

**900 Series
Industrial Ethernet
Switch**

**Installation
& User's Guide**

Industrial Ethernet Switch Installation Guide

900B/900N (3 Slot Enclosure and Backplane)

900B-FP (Filler Panel for empty slots)

908TX (Module)

902FX-SC (Module)

902FX-ST (Module)

902FXE-SC-YY (Module)

902FXE-ST-YY (Module)

904FX-SC (Module)

904FX-ST (Module)

904FXE-SC-YY (Module)

904FXE-ST-YY (Module)

Where: YY = -15, -40, or -80





Copyright, © N-TRON Corp., 2008
N-TRON Corp.
820 S. University Blvd., Suite 4E
Mobile, AL 36609

All rights reserved. Reproduction, adaptation, or translation without prior written permission from N-TRON Corp. is prohibited, except as allowed under copyright laws.

Ethernet is a registered trademark of Xerox Corporation. All other product names, company names, logos or other designations mentioned herein are trademarks of their respective owners.

The information contained in this document is subject to change without notice. N-TRON Corp. makes no warranty of any kind with regard to this material, including, but not limited to, the implied warranties of merchantability or fitness for a particular purpose. In no event shall N-TRON Corp. be liable for any incidental, special, indirect or consequential damages whatsoever included but not limited to lost profits arising out of errors or omissions in this manual or the information contained herein.

Warning

Do not perform any services on the unit unless qualified to do so.

Do not substitute unauthorized parts or make unauthorized modifications to the unit.

Do not operate the unit with the top cover removed, as this could create a shock or fire hazard.

Do not block the air vents on the sides or the top of the unit.

Do not operate the equipment in the presence of flammable gasses or fumes. Operating electrical equipment in such an environment constitutes a definite safety hazard.

Safety Warnings

ELECTRICAL SAFETY



WARNING: Disconnect the power cable before removing the enclosure top.

WARNING: Do not operate the unit with the top cover removed.

WARNING: Do not work on equipment or cables during periods of lightning activity.

WARNING: Do not perform any services on the unit unless qualified to do so.

WARNING: Do not block the air vents.

WARNING: Observe proper DC Voltage polarity when installing power input cables. Reversing voltage polarity can cause permanent damage to the unit and void the warranty.

LASER SAFETY (904FXE and 902FXE Only)



CAUTION: CLASS 1 LASER PRODUCT. Do not stare into the laser!

900 Series Hazardous Location Installation Requirements

1. **WARNING:** EXPLOSION HAZARD. DO NOT DISCONNECT UNIT WHILE CIRCUIT IS LIVE, UNLESS KNOWN TO BE NON-HAZARDOUS.
2. **AVERTISSEMENT:** RISQUE D'EXPLOSION. NE PAS DE BRANCHER TANT QUE LE CIRCUIT EST SOUS TENSION, A MOINS QU'IL S' A GISE D'UN EMPLACEMENT NON DANGEREUX.
3. **WARNING:** Install only in accordance with Local & National Codes of Authorities Having Jurisdiction.
4. **Power must be supplied by an isolating source, and a 3.3A max rated UL recognized fuse must be installed immediately before the unit.**
5. Class I, Div 2 installations require that all devices connected to this product must be UL listed for the area in which it is installed.
6. Only UL listed wiring with temperature ratings greater than 90°C permitted for Class I, Div 2 installations operating at temperatures up to 70°C ambient.
7. Limited Operating Voltage: 12-30V for Class I, Div 2 installations.

900 Series Industrial Ethernet Switches

The 900 Series Modular Industrial Ethernet Switches support high speed layer 2 switching between ports. The 900B and 900N enclosures contain a three slot backplane that supports up to three modules. The 908TX, 902FX and 904FX modules are the available modules. The N-TRON Corp. 900B is housed in a ruggedized steel enclosure, and can withstand industrial temperatures, as well as extreme shock & vibration.

The 908TX is an 8 port module that is capable of auto negotiating 10/100 Mb and half/full duplex communications. The N-TRON 908TX also supports MDIX auto sensing (for auto connector of straight through or crossover cables) and provides 8 Category 5 compliant 10/100-BaseT connections for high performance network design, and hub/repeater upgrades.

The 902FX is a two port 100Mb module that supports multimode fiber. ST and SC connectors are available.

The 902FXE is a single mode (laser) version of the 902FX, and can support distances of up to 80km.

The 904FX and 904FXE are four port versions of the 902FX and 902FXE respectively.

Key Features

- Full IEEE 802.3 & 100BASE-FX Compliance
- Extended Environmental Specifications
- Support for Full/Half Duplex Operation
- LED Link/Activity Status Indication
- Auto Sensing Speed and Flow Control
- Auto MDIX (908TX only)
- Up to 4.8 Gb/s Maximum Throughput
- Industry Standard DIN-Rail Enclosure

PACKAGE CONTENTS

Please make sure the Ethernet Switch package contains the following items:

1. 900 Series Ethernet Switch
2. Installed Modules
3. This Installation Guide

Contact your carrier if any items are damaged.

INSTALLATION

Read the following warning before beginning the installation:

WARNING



The 902FXE and 904FXE unit contain a class 1 laser. Do not stare into the laser beam (fiber optic connector) when installing or operating the product.



Never install or work on electrical equipment or cabling during periods of lightning activity.

Disconnect the power cable before removing the enclosure top.

Do not operate the unit with the top cover removed

UNPACKING

Remove all the equipment from the packaging, and store the packaging in a safe place.

File any damage claims with the carrier.

902FX/FXE & 904FX /FXE HALF DUPLEX SETUP

All 900 series fiber modules are factory configured for full duplex operation. The setting is controlled by jumper JP1 on the backplane.

Note: Most 100Mbit fiber systems will be compatible with this Full Duplex setting. If Half Duplex operation is desired, then follow these steps using proper wrist strap grounding techniques:

1. Remove the power & power plugs from the unit.
2. Loosen all thumbscrews & remove all modules.
3. Remove the six screws holding the backplane
4. Remove the backplane.
5. Move the jumper JP1 from position 1-2 to 3-4
6. Re-install the backplane & modules & power plugs.

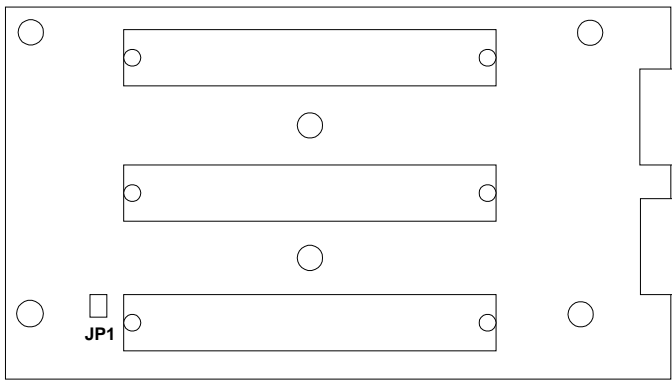

902/904 Note:

Rev. C & D boards are hard wired for Port1 = HDPLX,
Rev. B & E boards are hard wired for Port1 = FDPLX.

DIN-Rail Mounting

Install the unit in a standard DIN-Rail. Recess the unit to allow at least 5” of horizontal clearance for fiber optic cable bend radius (2” for TX models). Note: This unit may be mounted horizontally or vertically.

To install the unit to 35mm industrial DIN-Rail - Place the top edge of the included mounting bracket on the back of the unit against the top flange of the DIN-Rail at a 15° angle. Rotate the bottom of the unit to the back (away from you) until it snaps into place.

To remove the unit from the 35 mm industrial DIN-Rails - Apply downward force to the unit until it disengages from the bottom of the unit from the DIN-Rail. Then, rotate the unit approximately 15° upward and towards you to completely remove it.

Optional Mounting

The 900 Series Ethernet switches were designed to be mounted on industry standard 35mm DIN-Rail. However, DIN-Rail mounting may not be suitable for all applications. We offer two alternative mounting solutions.

Our 900 Panel Mount Assembly (P/N: 900-PM) may be used to securely mount the 900 Series products to a panel or other flat surface.

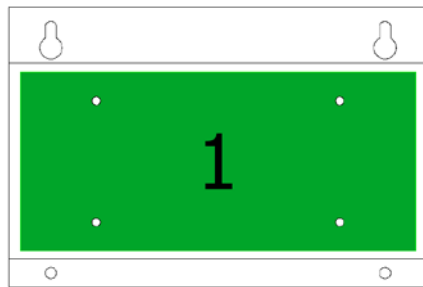

Our Universal Rack Mount Kit (P/N: URMK) may be used to mount our products to standard 19" racks.

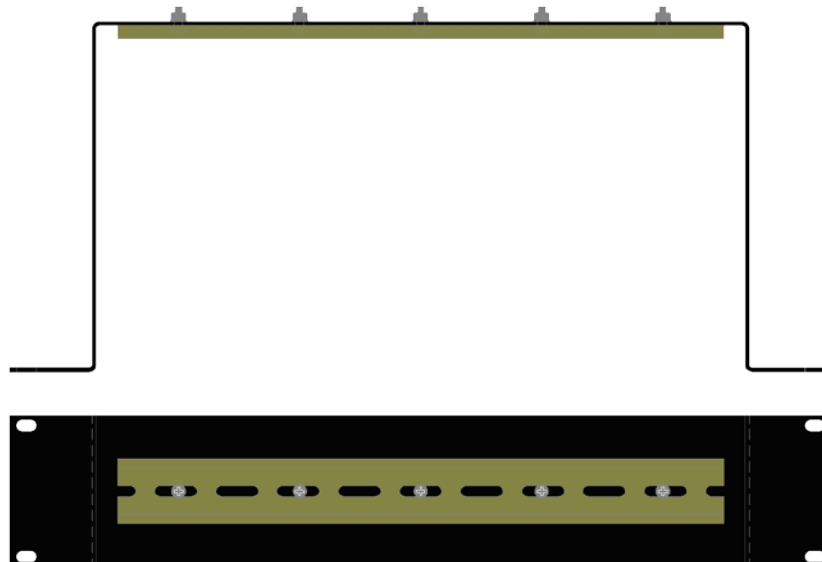

MODULE CONFIGURATION SETTINGS

In order for the 900 Series modules to communicate properly the chassis must be populated with modules from the top slot down as shown below. In addition, JP1 and JP2 jumpers (located on top side of all modules) *must* be configured as indicated below.

Note: The power source must be disconnected from the 900B chassis prior to removing and inserting modules. This unit is not hot swappable.

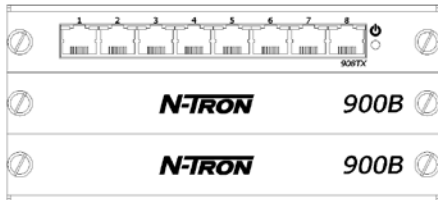

One Slot Configuration - When installing a *single* 902FX, 904FX, or 908TX module in the top slot of the 900B chassis... **Configure the module as follows:**

JP1: pins 1 & 2 shorted
JP2: pins 1 & 2 shorted

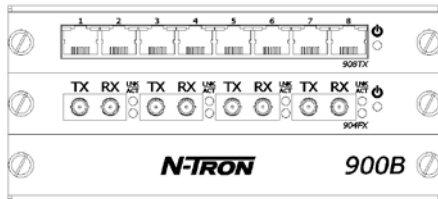
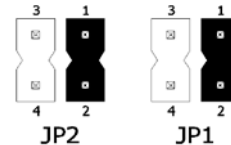

Two Slot Configuration - When installing *two* 902FX, 904FX, and/or 908TX modules in the top two slots of the 900B chassis... **Configure both modules as follows:**

JP1: pins 1 & 2 shorted
JP2: pins 3 & 4 shorted

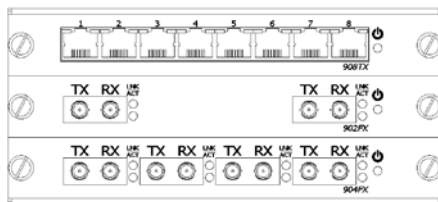
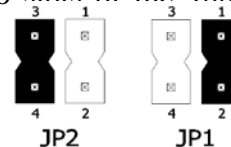

Three Slot Configuration - When installing *three* 902FX, 904FX, and/or 908TX modules in all three slots of the 900B chassis... **Configure all modules as follows:**

JP1: pins 3 & 4 shorted
JP2: pins 3 & 4 shorted

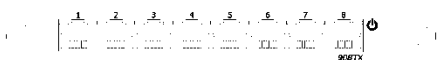
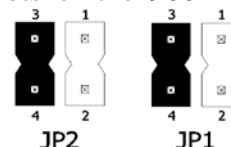

908TX Module - At power cycle, all LED's flash on for approximately two seconds, and then return to proper state. Green LED will light when Power is connected.

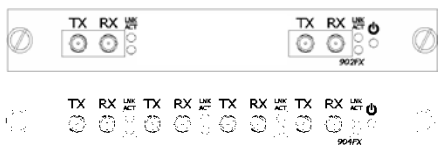

902FX & 904FX Modules - At power cycle, only the LED's on the first port flash on to indicate the reset condition, and then return to their proper state. All other reports remain off during reset. This is normal behavior. Green LED will light when Power is connected.

In order to verify the module jumper (JP1 & JP2) settings have been set correctly, for units which have the **N-View option turned on**, you should install N-ViewOPC Server software on a PC connected to the LAN. The software is freely distributed on the ProductCD and our web site (<http://www.n-tron.com/html/opc.html>). Once N-ViewOPC is installed, you should view the Ports Counter page to remotely monitor each connected port. You may find it helpful to Copy [Alt]+[PrintScreen] the Port Counter information for each port and Paste [Control]+[V] into a Windows document for further review. Please consult your N-View OPC Server Manual for additional information.

908TX Module



From Left to Right:

RJ45 Ports	Ports 1-8 Auto sensing 10/100BaseT Ports
Upper Left LED	Port Link Status
Upper Right LED	Port Activity Status
⏻	Green LED lights when Power is connected

Note: At power cycle, all LED's flash on for approximately two seconds, and then return to proper state.

LED's: The table below describes the operating modes:

LED	Color	Description
⏻	GREEN	Power is Applied
	OFF	Power is OFF
LNK	GREEN	Link between ports established
	OFF	No Link between ports
ACT	GREEN	Data is active between ports
	OFF	Data is inactive between ports

908 Module Jumper Settings

JP1 install jumper in location 1-2 when 1 or 2 modules installed
install jumper in location 3-4 when 3 modules installed

JP2 install jumper in location 1-2 when 1 module installed
install jumper in location 3-4 when 2 or 3 modules installed

902/904 FX & FXE Module



From Left to Right:

- TX** Fiber Optic Transmit Port
- RX** Fiber Optic Receive Port
- LNK** Link LED (top LED) for Fiber Optic Port
- ACT** Activity LED (bottom LED) for Fiber Optic Port
- ⏻** Green LED lights when Power is connected

Note: At power cycle, only the LED's on the first port flash on to indicate the reset condition, and then return to their proper state. All other reports remain off during reset. This is normal behavior.

LED's: The table below describes the operating modes:

LED	Color	Description
⏻	GREEN	Power is Applied
	OFF	Power is OFF
LNK	GREEN	Link between ports established
	OFF	No Link between ports
ACT	GREEN	Data is active between ports
	OFF	Data is inactive between ports

902/904 Module Jumpers Settings

- JP1** install jumper in location 1-2 when 1 or 2 modules are installed
install jumper in location 3-4 when 3 modules are installed
- JP2** install jumper in location 1-2 when 1 module are installed
install jumper in location 3-4 when 2 or 3 modules are installed

APPLYING POWER

1. Unscrew the flange & Remove the DC Voltage Input Plug(s) from the side headers.
2. Install the DC Power Cables into the Plug(s) (observing polarity).
3. Tightening torque for the terminal block power plug is **0.22 Nm/0.162 Pound Foot**.
4. Plug the Voltage Input Plug(s) back into the side header. All 10/100BaseT LED's will flash ON Momentarily. For fiber optic ports, only port 1 will flash momentarily.
5. Verify the Power LED stays ON (GREEN).

Note: Only 1 plug must be connected to power for minimal operation. For redundant power operation, V₁ and V₂ plugs must be connected to separate DC Voltage sources. Use wire sizes 16-28 gauge.

Recommended 24V DC Power Supplies, similar to

120/240VAC:

NTPS-24-3, 24VDC at 3A (NOTE: Not appropriate for use with M12, POE, and HV models.)

N-TRON SWITCH GROUNDING TECHNIQUES

The grounding philosophy of any control system is an integral part of the design. N-Tron switches are designed to be grounded, but the user has been given the flexibility to float the switch when required. The best noise immunity and emissions (i.e. CE) are obtained when the N-Tron switch chassis is connected to earth ground via a drain wire. Some N-Tron switches have metal din-rail brackets that can ground the switch if the din-rail is grounded. In some cases, N-Tron switches with metal brackets can be supplied with optional plastic brackets if isolation is required.

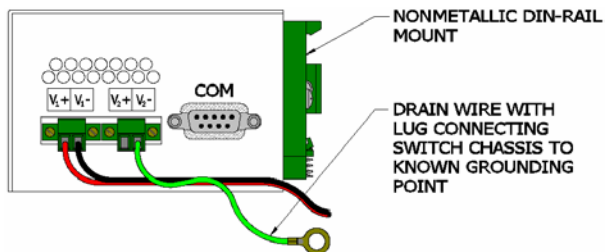

Both V- legs of the power input connector are connected to chassis internally on the PCB. Connecting a drain wire to earth ground from one of the V- terminal plugs as shown here will ground the switch and the chassis. The power leads from the power source should be limited to 3 meters or less in length.

As an alternate, users can run a drain wire & lug from any of the Din-Rail screws or empty PEM nuts on the enclosure. When using an unused PEM nut to connect a ground lug via a machine screw, care should be taken to limit the penetration of the outer skin by less than 1/4 in. Failure to do so may cause irreversible damage to the internal components of the switch.

Note: Before applying power to the grounded switch, you must use a volt meter to verify there is no voltage difference between the power supply's negative output terminal and the switch chassis grounding point.

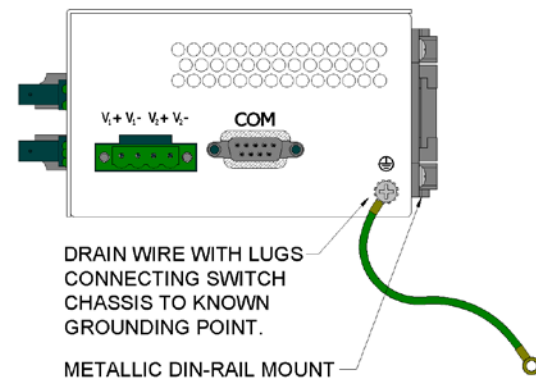

If the use of shielded cables is required, it is generally recommended to only connect the shield at one end to prevent ground loops and interfere with low level signals (i.e. thermocouples, RTD, etc.). Cat5e cables manufactured to EIA-568A or 568B specifications are required for use with N-Tron Switches.



In the event all Cat5e patch cable distances are small (i.e. All Ethernet devices are located the same local cabinet and/or referenced to the same earth ground), it is permissible to use fully shielded cables terminated to chassis ground at both ends in systems void of low level analog signals.

RJ45 CONNECTOR CRIMP SPECIFICATIONS

Please reference the illustration below for your Cat5 cable specifications:

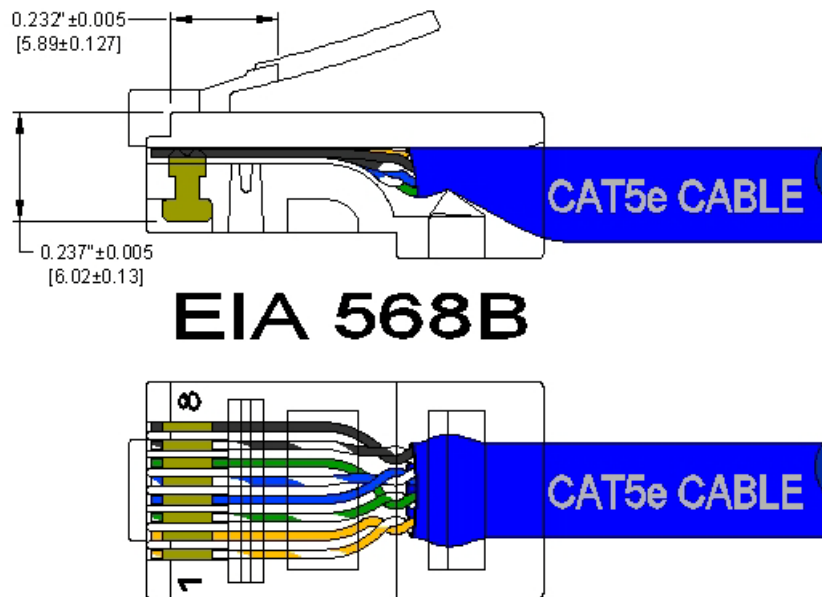



CONNECTING THE UNIT

For 902 & 904 FX & FXE units, remove the dust cap from the fiber optic connectors and connect the fiber optic cables. The TX port on the 902 and/or 904 units should be connected to the RX port of the far end station. The RX port on the 902 and/or 904 units should be connected to the TX port of the far end station.

For 10/100 Base-TX ports, plug a Category 5 twisted pair cable into the RJ45 connector. Connect the other end to the far end station. Verify that the LNK LED's are ON once the connection has been completed. For Switch to Switch or Switch to Repeater connections, since the 908TX supports the advanced MDIX function, there is no need to use crossover cables. The 908TX will sense & adapt accordingly.

Warning: Creating a port to port connection on the same switch (i.e. loop) is an illegal operation and will create a broadcast storm which will crash the network!

TROUBLESHOOTING

1. Make sure the  (Power LED) is ON.
2. Make sure the  (Error LED) remains OFF 3 seconds after initial power up.
3. Verify that Link LED's are ON for connected ports.
4. Verify straight through cabling used between stations.
5. Verify cabling (pin-outs & integrity).
6. Verify that cabling is Category 5 (or higher) for 100Mbit Operation.
7. Verify TX is connected to far end RX and vice versa (902 and 904 FX/FXE only).

SUPPORT

Contact N-TRON Corp. at:
TEL: 251-342-2164
FAX: 251-342-6353
Website: www.n-tron.com
E-Mail: N-TRON_Support@n-tron.com

FCC STATEMENT

This product complies with Part 15 of the FCC-A Rules.

Operation is subject to the following conditions:

- (1) This device may not cause harmful Interference
- (2) This device must accept any interference received, including interference that may cause undesired operation.

Key Specifications

Physical

Height:	3.2" (8.13 cm)
Width:	7.1" (18.03 cm)
Depth:	4.1" (10.41 cm)
Weight:	~3.0 lbs (2.3 kg)

(Note: This unit may be mounted horizontally or vertically)

Electrical

Input Voltage:	10-30 VDC (Regulated)
Input Current:	390 mA @ 24VDC (Steady State)
Input Ripple:	Less than 100 mV
Inrush Current:	13.7 Amp / 1.9 ms @ 24VDC with (3) 908TX modules
Inrush Current:	13.9 Amp / 1.9 ms @ 24VDC with (3) 904FX modules

Environmental

Operating Temperature:	-20°C to 70°C (-4°F to 158°F)
Storage Temperature:	-20°C to 85°C (-4°F to 185°F)
Operating Humidity: (Non-Condensing)	10% to 90%
Operating Altitude:	0 to 10,000 ft.

Shock and Vibration (Bulkhead Mounting)

Shock:	200g @ 10ms
Vibration:	1g, 10-500Hz, 3 axis
Seismic:	20g, 5-200Hz, 15s

Reliability

MTBF:	>1M Hours (measured)
-------	----------------------

Network Media

10BaseT:	> Cat-3 Cable
100BaseT:	> Cat-5 Cable
100BaseFX:	Multimode: 50-62.5/125µm Fiber Singlemode: 7-10/125µm Fiber

Fiber Transceiver Characteristics

Fiber Length:	2km*	15km**	40km**	80km**
TX Power Min/Max	-19dBm/-14dBm	-15dBm/-7dBm	-5dBm/0dBm	-5dBm/0dBm
RX Sensitivity Max:	-32dBm	-34dBm	-34dBm	-34dBm
Wavelength:	1310nm	1310nm	1310nm	1550nm

*=Multimode ** =Singlemode

Recommended Wiring Clearance:

Front:	2" (5.08 cm)
Side:	1" (2.54 cm)

Regulatory Approvals:

Safety: Listed as UL 1604 (US and Canada) Hazardous Locations, Class I, Zone 2, Group IIC, T4A

EMI: EN50081-1:1992, EN55022 – Class A
FCC Part 15 Class A

EMS: EN55024:1998
EN61000-4-2:1995
EN61000-4-3:1995
EN61000-4-4:1995
EN61000-4-5:1995
EN61000-4-6:1995

Note: *Shielded cables must be used to meet emission standards*

GOST-R Certified.



Ordering Information

<u>PN</u>	<u>Description</u>
900B	Industrial Ethernet switch chassis with 3 slots for optional expansion modules
URMK	19" Universal Rack Mount Kit
900-PM	Panel Mount Kit
908TX	Eight ports 10/100BaseTX (RJ45)
902FX-XX	Two ports 100BaseFX multimode fiber
902FXE-XX-YY	Two ports 100BaseFX singlemode fiber
904FX-XX	Four ports 100BaseFX multimode fiber
904FXE-XX-YY	Four ports 100BaseFX singlemode fiber

Where "XX" is: ST for ST style fiber connector
SC for SC style fiber connector

Where "YY" is: 15 for 15km max. fiber segment length
40 for 40km max. fiber segment length
80 for 80km max. fiber segment length

Warranty: Effective January 1, 2008, all N-TRON products carry a 3 year limited warranty from the date of purchase.

Contact/Support Information

N-TRON Corp.
820 S. University Blvd., Suite 4E
Mobile, AL 36609
TEL (251) 342-2164
FAX (251) 342-6353
Website: www.n-tron.com
E-Mail: N-TRON_Support@n-tron.com

N-TRON Limited Warranty

N-TRON, Corp. warrants to the end user that this hardware product will be free from defects in workmanship and materials, under normal use and service, for the applicable warranty period from the date of purchase from N-TRON or its authorized reseller. If a product does not operate as warranted during the applicable warranty period, N-TRON shall, at its option and expense, repair the defective product or part, deliver to customer an equivalent product or part to replace the defective item, or refund to customer the purchase price paid for the defective product. All products that are replaced will become the property of N-TRON. Replacement products may be new or reconditioned. Any replaced or repaired product or part has a ninety (90) day warranty or the remainder of the initial warranty period, whichever is longer. N-TRON shall not be responsible for any custom software or firmware, configuration information, or memory data of customer contained in, stored on, or integrated with any products returned to N-TRON pursuant to any warranty.

OBTAINING WARRANTY SERVICE: Customer must contact N-TRON within the applicable warranty period to obtain warranty service authorization. Dated proof of purchase from N-TRON or its authorized reseller may be required. Products returned to N-TRON must be pre-authorized by N-TRON with a Return Material Authorization (RMA) number marked on the outside of the package, and sent prepaid and packaged appropriately for safe shipment. Responsibility for loss or damage does not transfer to N-TRON until the returned item is received by N-TRON. The repaired or replaced item will be shipped to the customer, at N-TRON's expense, not later than thirty (30) days after N-TRON receives the product. N-TRON shall not be responsible for any software, firmware, information, or memory data of customer contained in, stored on, or integrated with any products returned to N-TRON for repair, whether under warranty or not.

ADVANCE REPLACEMENT OPTION: Upon registration, this product qualifies for advance replacement. A replacement product will be shipped within three (3) days after verification by N-TRON that the product is considered defective. The shipment of advance replacement products is subject to local legal requirements and may not be available in all locations. When an advance replacement is provided and customer fails to return the original product to N-TRON within fifteen (15) days after shipment of the replacement, N-TRON will charge customer for the replacement product, at list price.

WARRANTIES EXCLUSIVE: IF AN N-TRON PRODUCT DOES NOT OPERATE AS WARRANTED ABOVE, CUSTOMER'S SOLE REMEDY FOR BREACH OF THAT WARRANTY SHALL BE REPAIR, REPLACEMENT, OR REFUND OF THE PURCHASE PRICE PAID, AT N-TRON'S OPTION. TO THE FULL EXTENT ALLOWED BY LAW, THE FOREGOING WARRANTIES AND REMEDIES ARE EXCLUSIVE AND ARE IN LIEU OF ALL OTHER WARRANTIES, TERMS, OR CONDITIONS, EXPRESS OR IMPLIED, EITHER IN FACT OR BY OPERATION OF LAW, STATUTORY OR OTHERWISE, INCLUDING WARRANTIES, TERMS, OR CONDITIONS OF MERCHANTABILITY, FITNESS FOR A PARTICULAR PURPOSE, SATISFACTORY QUALITY, CORRESPONDENCE WITH DESCRIPTION, AND NON-INFRINGEMENT, ALL OF WHICH ARE EXPRESSLY DISCLAIMED. N-TRON NEITHER ASSUMES NOR AUTHORIZES ANY OTHER PERSON TO ASSUME FOR IT ANY OTHER LIABILITY IN CONNECTION WITH THE SALE, INSTALLATION, MAINTENANCE OR USE OF ITS PRODUCTS. N-TRON SHALL NOT BE LIABLE UNDER THIS WARRANTY IF ITS TESTING AND EXAMINATION DISCLOSE THAT THE ALLEGED DEFECT OR MALFUNCTION IN THE PRODUCT DOES NOT EXIST OR WAS CAUSED BY CUSTOMER'S OR ANY THIRD PERSON'S MISUSE, NEGLIGENCE, IMPROPER INSTALLATION OR TESTING, UNAUTHORIZED ATTEMPTS TO OPEN, REPAIR OR MODIFY THE PRODUCT, OR ANY OTHER CAUSE BEYOND THE RANGE OF THE INTENDED USE, OR BY ACCIDENT, FIRE, LIGHTNING, POWER CUTS OR OUTAGES, OTHER HAZARDS, OR ACTS OF GOD.

LIMITATION OF LIABILITY: TO THE FULL EXTENT ALLOWED BY LAW, N-TRON ALSO EXCLUDES FOR ITSELF AND ITS SUPPLIERS ANY LIABILITY, WHETHER BASED IN CONTRACT OR TORT (INCLUDING NEGLIGENCE), FOR INCIDENTAL, CONSEQUENTIAL, INDIRECT, SPECIAL, OR PUNITIVE DAMAGES OF ANY KIND, OR FOR LOSS OF REVENUE OR PROFITS, LOSS OF BUSINESS, LOSS OF INFORMATION OR DATA, OR OTHER FINANCIAL LOSS ARISING OUT OF OR IN CONNECTION WITH THE SALE, INSTALLATION, MAINTENANCE, USE, PERFORMANCE, FAILURE, OR INTERRUPTION OF ITS PRODUCTS, EVEN IF N-TRON OR ITS AUTHORIZED RESELLER HAS BEEN ADVISED OF THE POSSIBILITY OF SUCH DAMAGES, AND LIMITS ITS LIABILITY TO REPAIR, REPLACEMENT, OR REFUND OF THE PURCHASE PRICE PAID, AT N-TRON'S OPTION. THIS DISCLAIMER OF LIABILITY FOR DAMAGES WILL NOT BE AFFECTED IF ANY REMEDY PROVIDED HEREIN SHALL FAIL OF ITS ESSENTIAL PURPOSE.

DISCLAIMER: Some countries, states, or provinces do not allow the exclusion or limitation of implied warranties or the limitation of incidental or consequential damages for certain products supplied to consumers, or the limitation of liability for personal injury, so the above limitations and exclusions may be limited in their application to you. When the implied warranties are not allowed to be excluded in their entirety, they will be limited to the duration of the applicable written warranty. This warranty gives you specific legal rights which may vary depending on local law.

GOVERNING LAW: This Limited Warranty shall be governed by the laws of the State of Alabama, U.S.A.