

---

Model ES1AWBE  
*802.11b Wireless  
Serial Server*



**B&B electronics**  
MANUFACTURING COMPANY

---

Manual Documentation Number: ES1AWBE-2907m pn7042-rev002  
B&B Electronics Mfg Co Inc - 707 Dayton Rd - PO Box 1040 - Ottawa IL 61350 - Ph 815-433-5100 - Fax 815-433-5104 - [www.bb-elec.com](http://www.bb-elec.com)  
B&B Electronics Ltd - Westlink Commercial Park - Oranmore, Galway, Ireland - Ph +353 91-792444 - Fax +353 91-792445 - [www.bb-europe.com](http://www.bb-europe.com)





**International Headquarters**

B&B Electronics Mfg. Co. Inc.  
707 Dayton Road  
Ottawa, IL 61350 USA

**Phone** (815) 433-5100 -- **General Fax** (815) 433-5105

Website: [www.bb-elec.com](http://www.bb-elec.com)

**Sales e-mail:** [orders@bb-elec.com](mailto:orders@bb-elec.com) -- **Fax** (815) 433-5109

**Technical Support e-mail:** [support@bb.elec.com](mailto:support@bb.elec.com) -- **Fax** (815) 433-5104

**European Headquarters**

B&B Electronics Ltd.  
Westlink Commercial Park  
Oranmore, Co. Galway, Ireland

**Phone** +353 91-792444 -- **Fax** +353 91-792445

Website: [www.bb-europe.com](http://www.bb-europe.com)

**Sales e-mail:** [sales@bb-europe.com](mailto:sales@bb-europe.com)

**Technical Support e-mail:** [support@bb-europe.com](mailto:support@bb-europe.com)

© B&B Electronics – November 2005



---

© 2005 B&B Electronics. No part of this publication may be reproduced or transmitted in any form or by any means, electronic or mechanical, including photography, recording, or any information storage and retrieval system without written consent. Information in this manual is subject to change without notice, and does not represent a commitment on the part of B&B Electronics.

B&B Electronics shall not be liable for incidental or consequential damages resulting from the furnishing, performance, or use of this manual.

All brand names used in this manual are the registered trademarks of their respective owners. The use of trademarks or other designations in this publication is for reference purposes only and does not constitute an endorsement by the trademark holder.

---

Manual Documentation Number: ES1AWBE-2907m pn7042-rev002  
B&B Electronics Mfg Co Inc - 707 Dayton Rd - PO Box 1040 - Ottawa IL 61350 - Ph 815-433-5100 - Fax 815-433-5104 - [www.bb-elec.com](http://www.bb-elec.com)  
B&B Electronics Ltd - Westlink Commercial Park - Oranmore, Galway, Ireland - Ph +353 91-792444 - Fax +353 91-792445 - [www.bb-europe.com](http://www.bb-europe.com)



---

# ***Table of Contents***

---

---

Documentation Number: ES1AWBE-2907m    pn7042-rev002

B&B Electronics Mfg Co Inc – 707 Dayton Rd - PO Box 1040 - Ottawa IL 61350 - Ph 815-433-5100 - Fax 815-433-5104 – [www.bb-elec.com](http://www.bb-elec.com)

B&B Electronics Ltd – Westlink Commercial Park – Oranmore, Galway, Ireland – Ph +353 91-792444 – Fax +353 91-792445 – [www.bb-europe.com](http://www.bb-europe.com)

Table of Contents

i



<b>CHAPTER 1: INTRODUCTION.....</b>	<b>1</b>
ABOUT YOUR ES1AWB WIRELESS SERIAL SERVER.....	1
FEATURES.....	1
COMMUNICATION MODES .....	1
<i>Direct IP</i> .....	1
<i>Virtual COM Port</i> .....	1
<i>Paired Mode</i> .....	2
<i>Other Communications Modes</i> .....	2
802.11 WIRELESS NETWORKING BASICS .....	2
802.11 Wireless Networking .....	3
<b>CHAPTER 2: HARDWARE OVERVIEW .....</b>	<b>6</b>
PACKAGE CHECKLIST .....	6
INDICATORS, SWITCHES AND CONNECTORS.....	7
<i>Link Integrity LED</i> .....	7
<i>Network Activity LED</i> .....	7
<i>Reset Switch</i> .....	7
<i>Antenna Connector</i> .....	7
<i>Power Connector</i> .....	7
CONNECTING THE HARDWARE .....	8
OTHER HARDWARE CONNECTIONS.....	9
<b>CHAPTER 3: GETTING STARTED .....</b>	<b>10</b>
1. <i>Check the contents of your ES1AWB package. It should contain</i> .....	10
2. <i>Set up the Hardware</i> .....	10
3. <i>Power it Up</i> .....	10
4. <i>Get the IP Address</i> .....	11
5. <i>Login</i> .....	11
6. <i>Configure the ES1AWB</i> .....	11
7. <i>Set up VCOM (if using the RealPort profile)</i> .....	11
8. <i>Communicate</i> .....	11
<b>CHAPTER 4: CONFIGURING THE IP ADDRESS.....</b>	<b>12</b>
USING THE DISCOVERY SOFTWARE .....	12
<b>CHAPTER 5: USING THE WEB CONFIGURATION AND MANAGEMENT</b>	
<b>INTERFACE.....</b>	<b>14</b>
LOGGING IN.....	14
LOGGING OUT .....	14
USING TUTORIAL AND HELP.....	15
CONFIGURING NETWORK SETTINGS .....	15
<i>IP Settings</i> .....	16

---

Wireless LAN Settings.....	16
Wireless Security Settings.....	18
Wireless 802.1x Authentication Settings.....	18
Network Services Settings.....	18
Advanced Network Settings.....	18
CONFIGURING THE SERIAL PORT .....	19
Port Profile Settings.....	19
Basic Serial Settings .....	24
Advanced Serial Settings.....	24
CONFIGURING ALARMS AND NOTIFICATION.....	25
Alarm Notification Settings.....	25
Alarm Conditions.....	25
Alarm Destinations .....	26
<b>CHAPTER 6: MANAGING THE ES1AWB.....</b>	<b>28</b>
SYSTEM SETTINGS .....	28
Device Identity Settings.....	28
Simple Network Management Protocol (SNMP) Settings.....	28
USING REMOTE MANAGEMENT .....	28
MANAGING USERS AND PERMISSIONS .....	28
Changing the Root Username and Password .....	29
Adding New Users.....	29
Configuring User Access and Permissions .....	29
MANAGING SERIAL PORTS AND CONNECTIONS .....	30
Serial Ports .....	30
Connections .....	30
<b>CHAPTER 7: USING ADMINISTRATIVE FEATURES .....</b>	<b>32</b>
FILE MANAGEMENT.....	32
BACKUP/RESTORE .....	32
UPDATE FIRMWARE.....	32
FACTORY DEFAULT SETTINGS .....	32
SYSTEM INFORMATION .....	33
General .....	33
GPIO.....	33
Serial.....	33
Network.....	34
REBOOT .....	35
<b>CHAPTER 8: USING REALPORT .....</b>	<b>36</b>
Configuring the IP Address.....	36
Configuring the Serial Port for RealPort.....	36

---

---

<i>Adding a Virtual COM Port using RealPort</i> .....	37
<i>Removing a Virtual COM Port using RealPort</i> .....	37
<i>Updating RealPort</i> .....	38
<b>APPENDIX A: DEFAULT CONFIGURATION SETTINGS</b> .....	<b>40</b>
<b>APPENDIX B: PRODUCT SPECIFICATIONS</b> .....	<b>42</b>
<b>APPENDIX C: ES1AWB DIMENSIONAL DIAGRAM</b> .....	<b>44</b>
<b>APPENDIX D: RS-232 CONNECTIONS</b> .....	<b>46</b>



---

# Chapter 1: Introduction

---

**Thank you for purchasing an ES1AWB Wireless Serial Server.** Like all B&B Electronics products, your serial server has been manufactured to high standards of quality and performance to ensure your complete satisfaction. Please read this manual and carefully follow the instructions to achieve best results. For additional information on this and other products and for technical support, contact B&B Electronics.

## About Your ES1AWB Wireless Serial Server

**ES1AWB Wireless Serial Servers** are part of B&B Electronics' growing family of device servers, products that allow you to connect equipment with available serial connections into existing networks. ES1AWB wireless serial servers connect RS-232 devices to a wireless network via wireless access points, eliminating the need for network cabling. Based on the 802.11b wireless standard, ES1AWB servers operate at up to 11 Mbps over the 2.4 GHz band, which does not require licensing.

A serial device connected to the serial port on your ES1AWB can be accessed from any node on the LAN using **virtual COM port, console management, TCP and UDP socket, serial bridge, modem emulation and custom connections**. Network addresses can be obtained dynamically or manually. Simple Network Management Protocol (SNMP) is supported. Configuration is accomplished through a web-based user interface.

## Features

- Wireless networking at up to 11 Mbps on the 2.4 GHz band, as specified by the 802.11b standard
- Serial port supports RS-232 using a standard DB-M connector
- Supports TD, RD, TRS, CTS, DTR, DCD, DSR and GND RS-232 lines
- LAN and WAN Communications via wireless access point
- TCP or UDP Client or Server operation - configurable

---

Manual Documentation Number: ES1AWBE-2907m pn7042-rev002

B&B Electronics Mfg Co Inc - 707 Dayton Rd - PO Box 1040 - Ottawa IL 61350 - Ph 815-433-5100 - Fax 815-433-5104 - [www.bb-elec.com](http://www.bb-elec.com)

B&B Electronics Ltd - Westlink Commercial Park - Oranmore, Galway, Ireland - Ph +353 91-792444 - Fax +353 91-792445 - [www.bb-europe.com](http://www.bb-europe.com)



- Software Support - Windows 98/ME/2000/XP/NT 4.0 or Vista
- Firmware upload for future revisions/upgrades
- Small compact case
- LEDs indicate link integrity and data transfer activity
- Web Configuration and Management user interface
- Email event notification

## Communication Modes

**ES1AWB Wireless Serial Servers** allow you to connect serial devices over a wireless network. The connection can be configured in several modes.

### **Direct IP**

**Direct IP Mode** allows applications using TCP/IP or UDP/IP socket programs to communicate with the asynchronous serial ports on the serial server. In this mode the ES1AWB is configured as a TCP or UDP server. The socket program running on the PC establishes a communication connection. The data is sent directly to and from the serial port on the server.

- **TCP Server Mode** allows network devices to initiate a TCP connection to the serial device connected to the serial port on the ES1AWB. This is also referred to as reverse telnet.
- **UDP Server Mode** allows network devices to initiate a UDP connection to the serial device attached to the serial port of the ES1AWB. When using UDP protocol the ES1AWB can be configured to broadcast data to and receive data from multiple IP addresses.

### **Virtual COM Port**

**Virtual COM Port** mode (also called COM port redirection) allows you to map a COM port on your PC to the serial port on your ES1AWB. Using the RealPort software (included with the ES1AWB) you create virtual COM ports on your PC. When your application sends data to this port, RealPort redirects the data across the network to serial device connected to the ES1AWB serial port. The network is transparent to the user application and the serial device connected to the ES1AWB.

## Paired Mode

**Paired Mode** (also called **Serial Tunneling** or **Serial Bridge** mode) allows serial devices connected to two ES1AWB serial servers to communicate across a network. The two ES1AWB serial servers automatically connect to each other.

In Paired Mode the **heartbeat feature** ensures reliable communications by restoring the connection if communications are temporarily lost at either end due to loss of power or Ethernet connection.

## Other Communications Modes

ES1AWB Wireless Serial Servers also feature the following communications profiles:

**Modem Emulation Mode** allows you to configure the serial port to operate as if it is a modem. For legacy applications where a serial device is set up to communicate through a modem, the serial device can now be connected to the ES1AWB and communication occurs over the network. The ES1AWB emulates modem responses to and from the serial device.

In **Console Management Mode** the ES1AWB can be configured for connection to the management port typically found on network devices such as routers, switches and servers. This allows remote management of the network device. Communication can be accomplished using telnet to a specific port in the serial server.

**Custom Mode** allows you to custom configure the ES1AWB serial port and is used if your application does not fit into any other predefined modes.

## 802.11 Wireless Networking Basics

**ES1AWB wireless serial servers** allow you to connect non-network-enabled serial devices into a wireless network, giving you the capability to gather more data and implement remote programming and management. Serial devices no longer are limited to a physical connection to a PC. The serial device can be connected to an ES1AWB wireless serial server anywhere within range of an 802.11b-compatible wireless access point. Communication occurs transparently using TCP/IP or UDP/IP over a wireless link. This allows traditional Windows PC software access to serial devices anywhere on the wireless network.

---

The enabling technology for ES1AWB wireless serial servers is based on the IEEE 802 standard. Some background on the standard follows.

## 802.11 Wireless Networking

**IEEE 802.11** is a set of standards that defines how multiple devices can communicate on a wireless network. The standard has grown into a set of several standards that define various features and functions. The 802.11b standard defines the physical and data link layers for a wireless network using the 2.4 GHz frequency band, a band that does not require licensing. As a part of the IEEE family of standards, 802.11 WLANs are easily connected to 802.3 (Ethernet) LANs. Higher layer LAN protocols, network operating systems and internetworking protocols such as TCP/IP integrate seamlessly.

Under the IEEE 802.11 standard there can be two different types of devices on the wireless network: *stations* and *access points (AP)*. A **station** may be a PC equipped with a wireless network adapter or it can be a wireless serial server such as the ES1AWB. An 802.11 **access point** is a radio with an interface that allows connection to a wired LAN. Access points run bridging software to facilitate the connection from wireless to wired network. The access point becomes the base station for the WLAN. It aggregates access to the wired network for multiple wireless stations. An access point may be a standalone device, such as a wireless router or switch, or a card in a PC.

### Wireless Network Configurations

The 802.11 standard defines two modes of operation: *infrastructure mode* and *ad hoc mode*. **Infrastructure mode** makes use of one or more access points connected to a wired LAN. Wireless stations communicate with access points to gain access to each other and/or the LAN. In the Basic Service Set (BSS) several stations communicate with one access point, which is connected to a wired LAN. In the Extended Service Set (ESS) two or more access points connect to the LAN creating a sub network.

In **ad hoc mode**, also called Independent Basic Service Set (IBSS), access points are not used. Wireless stations communicate directly with each other in a peer-to-peer fashion. This mode allows individual computers to set up a network where wireless infrastructure does not exist.

ES1AWB wireless serial servers can be configured to operate in infrastructure or ad hoc mode. From the Web Configuration and Management Interface you can set up the type of network, naming the network (specifying the SSID, or service set identifier) and other parameters.

## **IEEE 802.11b**

IEEE 802.11b standard specifies a WLAN that operates on the 2.4 GHz band at data rates up to 11 Mbps. Equipment that conforms to the 802.11b standard can interoperate with equipment conforming to faster (up to 54 Mbps) 802.11g equipment and they will interoperate. However, when connected into the same network the 802.11g equipment will operate at the 11 Mbps limitation of the 802.11b equipment.

For media access, 802.11 wireless networks use CSMA/CA, a scheme in which a station that intends to transmit 'listens' for traffic on the radio carrier frequency and sends data packets if the frequency is clear. If the receiving station receives the packet intact it sends an acknowledgement (ACK) to confirm the packet has been received. If the transmitting station does not receive an ACK it assumes a collision occurred and transmits again after a random delay period.

Communication distances vary depending on the type and thickness of material around a wireless node. The transmitter power output, the type of antenna used and the amount of attenuation through materials also affects the useable range. Electromagnetic noise, reflections, the amount of network traffic, other radio devices operating in the same frequency band also affect range and overall performance. In an infrastructure network the number of access points and their coverage pattern also affect how well the system operates. Typically an 802.11 device operating indoors will have a range from 100 feet minimum to about 500 feet maximum. Outdoors, some products, using high gain antennae may achieve line-of-sight ranges of five miles or more.

Security is a significant concern for WLAN users. Whether security threats originate intentionally or unintentionally, wireless systems are more susceptible than wired systems. ES1AWB serial servers offer several security options including WEP (Wired Equivalent Privacy), WPA (Wi-Fi Protected Access), PEAP (Protected EAP) w/EAP-MS-CHAPv2 and others.

---

Manual Documentation Number: ESIWBE-2907m pn7042-rev002

B&B Electronics Mfg Co Inc - 707 Dayton Rd - PO Box 1040 - Ottawa IL 61350 - Ph 815-433-5100 - Fax 815-433-5104 - [www.bb-elec.com](http://www.bb-elec.com)

B&B Electronics Ltd - Westlink Commercial Park - Oranmore, Galway, Ireland - Ph +353 91-792444 - Fax +353 91-792445 - [www.bb-europe.com](http://www.bb-europe.com)

---

## Chapter 2: Hardware Overview

---

### Package Checklist

ES1AWB Wireless Serial Servers are shipped with the following items included:

- ✓ The ES1AWB module
- ✓ A printed version of this user manual
- ✓ A printed version of the ES1AWB Quick Start Guide
- ✓ CD-ROM disc with
  - B&B discovery software
  - RealPort drivers for Windows 98/ME/2000/XP/NT 4.0/Vista
  - This manual in PDF format
  - The ES1AWB Quick Start Guide in PDF format



Figure 1. Front View of the ES1AWB Serial server

---

# Indicators, Switches and Connectors

## Link Integrity LED

- When the **yellow LED** is illuminated it indicates that a **connection (link integrity) has been established** between the serial server and an access point.
- If this LED is blinking slowly the ES1AWB is in **ad hoc** mode.
- If this LED is blinking quickly the ES1AWB is **scanning for a network**.

## Network Activity LED

When the **green LED** is flashing it indicates data is being sent across the network.

## Reset Switch

The **Reset** switch is a recessed switch located on the side of the ES1AWB. The Reset switch operates as follows:

- **Press for at least 1 second, release in less than 10 seconds:** reset serial server operating system
- **Press and hold 10+ seconds:** reset serial server to factory default settings.

## Antenna Connector

The antenna connector is a reverse SMA connector.

*An omni-directional antenna is supplied with ES1AWB wireless serial servers. All ES1AWB serial servers are FCC-certified when the supplied antenna is used.*

## Power Connector

The power connector is a 5.5mm by 2.1mm barrel jack the out side is negative (-) power supply. The tip or inside is positive (+) power supply. The power supply voltage range is 5 VDC.

## Connecting the Hardware

A typical connection for the **ES1AWB Wireless Serial Server** is infrastructure mode operation, in which the ES1AWB communicates with a PC on a wired network via an access point, which is often a wireless switch or router.

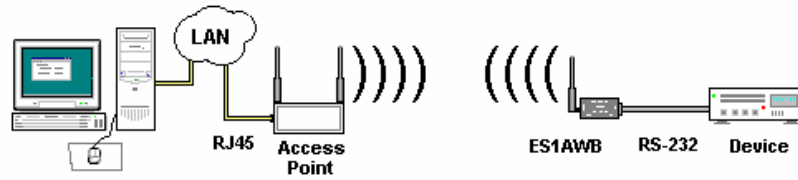

Figure 2. Connection via the Wireless LAN

# Other Hardware Connections

The ES1AWB Wireless Serial Server also can communicate directly with a PC equipped with a wireless card (in ad hoc mode).

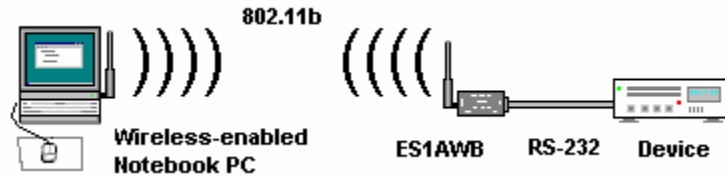

Figure 3. Wireless Ad Hoc Connection

In Serial Tunneling mode two serial devices can communicate via two ES1AWB Wireless Serial Servers.

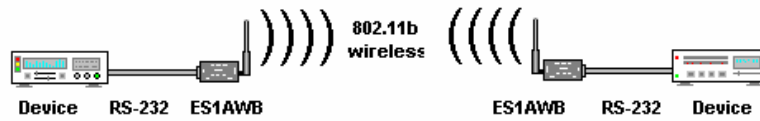

Figure 4. Serial Tunneling Ad Hoc Connection

Serial tunneling also can occur between two ES1AWB serial servers communicating with individual access points and across a wired network.

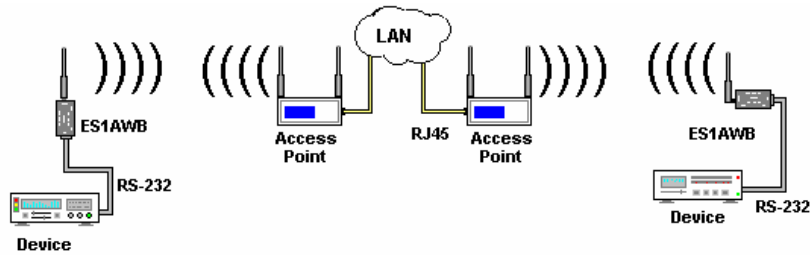

Figure 5. Serial Tunneling via Infrastructure

---

## Chapter 3: Getting Started

---

### 1. Check the contents of your ES1AWB package. It should contain...

- The ES1AWB module with SMA antenna
- A printed version of this user manual
- A printed version of the ES1AWB Quick Start Guide
- CD-ROM disc with discovery software, RealPort software, this manual and Quick Start guide

### 2. Set up the Hardware

- Connect your PC to the network
- Connect the antenna to the ES1AWB
- Connect the ES1AWB serial port to the serial port on your serial device

*For RS-232 operation, your ES1AWB is configured as a DTE and uses a DB-9M connector. Use a straight through RS-232 cable if your serial device is configured as a DCE. If your serial device is configured as a DTE you will have to use a null modem (crossover) cable.*

### 3. Power it Up

- Connect the 5VDC power supply to the ES1AWB
- The yellow LED will blink while looking for a wireless network. When a connection is established with the network the yellow LED will remain on steadily.
- The ES1AWB will automatically try to obtain an IP address (dynamically). If it cannot find a DHCP server, it will generate an IP address itself. It will look for a wireless network with the name (SSID) *Connect* first. If it does not find the SSID it will connect to the first unsecured network it finds.

*If you are configuring your own access point (a wireless switch or router) ensure that it is configured as a DHCP server with the Wireless Network Name (SSID): *Connect**

---

Manual Documentation Number: ES1AWBE-2907m pn7042-rev002

B&B Electronics Mfg Co Inc – 707 Dayton Rd - PO Box 1040 - Ottawa IL 61350 - Ph 815-433-5100 - Fax 815-433-5104 – [www.bb-elec.com](http://www.bb-elec.com)  
B&B Electronics Ltd – Westlink Commercial Park – Oranmore, Galway, Ireland – Ph +353 91-792444 – Fax +353 91-792445 – [www.bb-europe.com](http://www.bb-europe.com)

---

#### **4. Get the IP Address**

- ❑ Use the discovery software on your CD (finder.exe) to get the IP address for your ES1AWB

#### **5. Login**

- ❑ In a web browser on your PC, type in the IP address and access the Web Configuration and Management Interface
- ❑ Login using the username 'root' and password 'dbps'

#### **6. Configure the ES1AWB**

- ❑ In the Configuration, Network page configure your Wireless LAN, Security and other settings required to work on the type of wireless network you will be connecting to.
- ❑ In the Configuration, Serial Ports page select the Port Profile you require for use with your application (E.g. RealPort for virtual COM port, TCP Server, UDP server, Serial Bridge, etc)
- ❑ Configure the serial port settings for the selected Port Profile (e.g. In TCP Sockets select client or server, TCP port numbers, etc. Also configure baud rate, data bits, etc in Basic Serial Settings.
- ❑ Configure any required alarms and notification
- ❑ If RealPort profile was selected (virtual COM port) do the next step (Set up VCOM)

#### **7. Set up VCOM (if using the RealPort profile)**

- ❑ Start the RealPort software wizard (located on the included CD)
- ❑ Select Add a New Device
- ❑ Select your ES1AWB from the list
- ❑ Select an unused COM port number
- ❑ Follow the wizard to set up a virtual COM port

#### **8. Communicate**

- ❑ Configure and then start your application

## Chapter 4: Configuring the IP Address

Before you can begin the configuration of your ES1AWB you must know its IP address to access it with a web browser. Once you have access to the **Configuration and Management Interface** via a web browser you can reset the IP address using static IP addressing, if necessary.

Your ES1AWB comes from the factory configured to obtain an IP address dynamically, or failing that, to generate its own IP address using the APIPA protocol. You can determine the current IP address using the discovery software included on the CD with your ES1AWB.

### Using the Discovery Software

1. Power up the ES1AWB. The yellow LED will blink while looking for a wireless network. When a connection is established with the network the yellow LED will remain on steadily. The ES1AWB will then obtain or generate an IP address.
2. To determine the initial IP address of your ES1AWB, start the *finder.exe* utility included on the included CD.

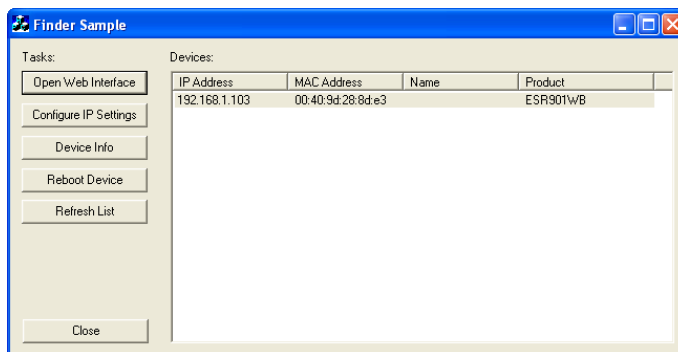

Figure 6. Discovery Utility Dialog

3. The finder.exe utility scans the network for devices and then lists each device's **IP Address**, **MAC Address**, **Name** and **Product ID**.

Identify your ES1AWB by its MAC address (printed on a label on the ES1AWB).

If you need to change the IP address of the ES1AWB, you can accomplish this using the Discovery software, or you can open the Web Configuration and Management Interface and do it there. (See **Configuring Network Settings** later in the next chapter.)

1. To change the IP address of the ES1AWB from the discovery software, click **Configure IP Settings**.
2. In the dialog that appears, select **Manually configure network settings**.
3. Type the new **IP Address**, **Subnet Mask**, **Default Gateway** and system password (initially *dbps*) in the appropriate boxes, then click **Apply**.
4. Click **Reboot Device**. This may take a minute or more to complete.
5. Click **Refresh List** to confirm the new IP address has been accepted.

## Chapter 5: Using the Web Configuration and Management Interface

---

The **ES1AWB Serial Server** can be configured using the **Configuration and Management Interface** via a standard web browser such as Internet Explorer or Firefox.

### Logging In

1. Before you can begin configuring your ES1AWB Serial server, you must login to the **Configuration and Management Interface**. To **login**, open your browser, type the IP address of your ES1AWB serial server into the address bar and press **Enter**. The **Login** page will appear.
2. Enter your **Username** and **Password**, then click **Login**.

The first time you login, type the default (root) username and password.

- **Username: root**
- **Password: dbps**

*The default username and password are preconfigured to give you full administrator permissions, allowing you to add and configure permissions for additional users. For security purposes, you may want to change the username and password after you have accessed the interface for the first time. To change usernames and passwords, and to add and configure new users, see *Managing Users and Permissions* in Chapter 6.*

When the username and password are accepted the **Configuration and Management Interface** homepage will appear.

### Logging Out

To log out of the Web Configuration and Management Interface, click **Logout** on the menu bar. To finish logging out of the web server, and prevent access by other users, you also must close the browser.

## Using Tutorial and Help

You can access the **ES1AWB Tutorial** by clicking **Tutorial** on the Configuration and Management homepage. Clicking **Help** on any page of the Configuration and Management Interface opens topics specific to that page.

*After logging in, if there is no activity for a period of time your session may time out. Clicking on any link will return you to the Web Login page where you will have to log in again to continue your session.*

Figure 7. The ES1AWB Configuration and Management Homepage

## Configuring Network Settings

The **Network Configuration** page contains six sections with hyperlinked menu bars.

- IP Settings
- Wireless LAN Settings
- Wireless Security Settings
- Wireless 802.1x Authentication Settings
- Network Services Settings
- Advanced Network Settings

Figure 8. Network Configuration, IP Settings Page

## IP Settings

The **IP Settings** section allows you to select between dynamic or static IP addressing. The ES1AWB's default setting is **Obtain an IP address automatically using DHCP**, or dynamic IP addressing.

*When the ES1AWB is first connected it will try to obtain an IP address automatically. If it fails, it will assign an IP address to itself using the Automatic Private IP Addressing (APIPA) protocol. You can re-configure the ES1AWB for static IP address by selecting Use the following IP address and assign the IP address yourself.*

If **Use the following IP address:** is selected, you are choosing static IP addressing. When this option is selected the **IP Address**, **Subnet Mask** and **Default Gateway** text boxes become available. You must determine the appropriate parameters and enter them yourself. (If you do not know what to enter ask your network administrator for assistance.)

To implement any changes in this section, click **Apply**. A page will appear asking you to **Reboot** the ES1AWB so that the changes can take effect.

## Wireless LAN Settings

The **Wireless LAN Settings** section allows you to specify the **Network Name** or **SSID** (Service Set Identifier). Multiple wireless networks sometimes exist. Specifying the network name allows your ES1AWB serial

server to connect to and associate with a specific network. If the network name is left blank the serial server will connect to the first available network.

Figure 9. Network Configuration, Wireless LAN Settings

By making the appropriate selection you can configure your serial server to

- **Connect to any available wireless network**
- **Connect to access point (infrastructure) networks only**
- **Connect to peer-to-peer (ad-hoc) networks only**

Select a **Country** from the dropdown list to restrict the channel settings to the legal set for that country.

Select a specific wireless **Channel** to restrict the serial server to a specific channel. Select **Auto-Scan** to allow the serial server to scan all frequencies until it finds an available access point to wireless network it can join.

Select **Enable Short Preamble** if your wireless network supports this feature. Short preambles can boost throughput.

## Wireless Security Settings

The **Wireless Security Settings** section is divided into several subsections including:

- **Network Authentication**
- **Data Encryption**
- **WEP Keys**
- **WPA PSK**
- **Username/Password**

Multiple options can be accessed under each security-related area. For Network Authentication and Data Encryption selecting **Any** enables all methods and the actual method used will depend on the capabilities of the wireless network.

*[Access the online Help file for detailed descriptions of these settings.](#)*

---

## Wireless 802.1x Authentication Settings

The **Wireless 802.1x Authentication Settings** section is available only if WEP with 802.1x authentication or WPA with 802.1x authentication have been selected in the Wireless Security Settings area.

*[Access the online Help file for detailed descriptions of these settings.](#)*

---

## Network Services Settings

The **Network Services Settings** section allows you to enable or disable several common network services and configure their associated ports. Typically you will not have to change these settings.

*[Access the online Help file for detailed descriptions of these settings.](#)*

---

## Advanced Network Settings

The **Advanced Network Settings** section allows you to fine tune the network connection. Typically these setting will not need to be changed.

*[Access the online Help file for detailed descriptions of these settings.](#)*

---

## Configuring the Serial Port

The **Serial Port Configuration** page displays information about the serial port on your ES1AWB, including its description, its profile (operating mode) and serial settings (baud rate, data bits, parity, stop bits). You will have to configure these parameters to set up your system for the type of operation required and to match the parameters of the serial device to which the ES1AWB is connected.

To open the **Serial Port Configuration** page, under the **Configuration** menu click **Serial Ports**. When you first access this page a list of ports, their description, profile and serial configuration appears. (If the ES1AWB has not yet been configured for the first time the Profile column may indicate <Unassigned>.)

To access detailed settings for the ES1AWB serial port, click **Port 1**. The **Serial Port Configuration** page that appears includes three sections with hyperlinked menu bars.

- **Port Profile Settings**
- **Basic Serial Settings**
- **Advanced Serial Settings**

### **Port Profile Settings**

The **Port Profile Settings** section displays the current serial port mode of operation, a description of that profile and a hyperlink to **Change Profile...**

Click the **Change Profile...** menu bar to open the **Select Port Profile** page. Any of eight possible serial port profiles can be selected.

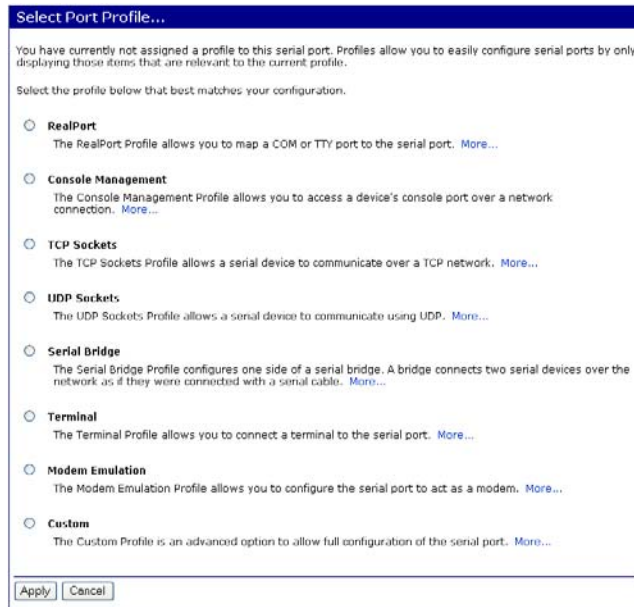

Figure 10. Select Port Profile Page

## RealPort

Select **RealPort** to implement the use of virtual COM ports. This allows you to map a COM port on a PC to the serial port on your ES1AWB. Using RealPort software (included with the ES1AWB) you create a virtual COM port on the PC. When your application sends data to this port, RealPort redirects the data across the network to the ES1AWB. The ES1AWB passes the data to the serial device connected to its serial port. The network is transparent to the user application and the serial device connected to the ES1AWB.

*For information on how to use RealPort to create virtual COM ports on your PC see Chapter 8*

## Console Management

In **Console Management** the ES1AWB can be configured for connection to the management port typically found on network devices such as routers, switches and servers. This allows remote management of the network device. Communication can be accomplished using telnet to a specific port in the serial server.

## TCP Sockets

Select **TCP Sockets** to implement **Direct IP Mode** using **TCP**. When using TCP Sockets your serial server can be configured as a **TCP server** or **TCP client**.

### TCP Server Settings

If your ES1AWB is configured as a TCP server, other network devices can initiate a TCP connection with the serial device connected to the ES1AWB serial port. (This is also referred to as *reverse telnet*.) Network devices initiating connections must be configured with the IP address of the ES1AWB and the TCP port number associated with its serial port.

After selecting **TCP Sockets**, click **Apply** to return to the **Serial Port Configuration** page. Select the **TCP Server Settings** as required by your application.

The screenshot shows the 'Serial Port Configuration' web interface. Under the 'Port Profile Settings' section, the current profile is 'TCP Sockets'. Below this, the 'TCP Server Settings' section is active, displaying instructions to connect directly to the serial device using TCP ports. Three options are listed, each with a checked checkbox and a text input field for the port number:

- Enable Telnet access using TCP Port:   Enable TCP Keep-Alive
- Enable Raw TCP access using TCP Port:   Enable TCP Keep-Alive
- Enable Secure Socket access using TCP Port:   Enable TCP Keep-Alive

Figure 11. TCP Server Settings

For each option, the TCP port number is shown. You can also **Enable TCP Keep Alive** for each selection. (If **Enable Keep Alive** is selected the connections is maintained even if no data is being sent.)

### TCP Client Settings

If your ES1AWB is configured as a TCP client it will automatically establish a bi-directional TCP connection between the serial device and a server or other networked device. Selecting **Automatically establish TCP connections** enables this feature and its configuration options become available.

TCP Client Settings

Automatically establish bi-directional TCP connections between the serial device and a server or other networked device.

- Automatically establish TCP connections  
Establish connection under one of the following conditions:
  - Always connect and maintain connection
  - Connect when data is present on the serial line  
Match string:
  - Strip string before sending
  - Connect when DCD (Data Carrier Detect) line goes high
  - Connect when DSR (Data Set Ready) line goes high

Establish connection to the following network service:

IP Address:

Service:

TCP Port:

Enable TCP Keep-Alive

Figure 12. TCP Client Settings

Consult the Tutorial and online Help for more detail.

## UDP Sockets

Select **UDP Sockets** to implement **Direct IP Mode** using **UDP** protocol. When using UDP Sockets your serial server can be configured as a **UDP server** or **UDP client**.

### UDP Server Settings

If your ES1AWB is configured as a UDP server, other network devices can initiate a UDP connection with the serial device connected to the ES1AWB serial port. Network devices initiating connections must be configured with the IP address of the ES1AWB and the UDP port number associated with its serial port.

After selecting **UDP Sockets**, click **Apply** to return to the **Serial Port Configuration** page. Select the **TCP Server Settings** as required by your application.

**Serial Port Configuration**

**Port Profile Settings**

Current Port Profile: **UDP Sockets** [Change Profile...](#)  
 The UDP Sockets Profile allows a serial device to communicate using UDP.

**UDP Server Settings**

The serial device receives data from one or more devices or systems on the network using UDP sockets.

Enable UDP access using UDP Port:

Figure 13. UDP Server Settings

### UDP Client Settings

If your ES1AWB is configured as a UDP client you can automatically distribute serial data from you ES1AWB to many devices at the same time. This is sometimes referred to as *Data Distribution* or *UDP Multicast*.

**UDP Client Settings**

Automatically send serial data to one or more devices or systems on the network using UDP sockets.

Automatically send serial data  
 Send data to the following network services:

Description	Send To	UDP Port	
No destinations currently configured			
<input type="text"/>	<input type="text" value="0.0.0.0"/>	<input type="text" value="0"/>	<input type="button" value="Add"/>

Send data under any of the following conditions:

Send when data is present on the serial line  
 Match string:   
 Strip string before sending

Send after following number of idle milliseconds  
 ms

Send after the following number of bytes  
 bytes

Figure 14. UDP Client Settings

You can configure multiple destinations. In the appropriate boxes, type the **Description**, **Send To** IP address or DNS name and **UDP Port** number, then click **Add**. You can also configure the conditions under which to send data.

*Consult the Tutorial and online Help for more detail.*

## ***Serial Bridge***

Select **Serial Bridge** to implement Paired Mode (also called serial tunneling). This allows serial devices connected to two ES1AWB serial servers to communicate across the network. The two ES1AWB serial servers automatically connect to each other.

## ***Modem Emulation***

Select **Modem Emulation** to configure the serial port to operate as if it is a modem. For legacy applications where a serial device is set up to communicate through a modem, the serial device can be connected to the ES1AWB and communication occurs over the network. The ES1AWB emulates modem responses to and from the serial device.

## ***Custom***

Select **Custom** to custom configure the ES1AWB serial port and is used if your application does not fit into any other predefined modes. This is an advanced option that allows full configuration of the serial port.

## ***Apply***

After you have selected a port profile, click the **Apply** button. The **Serial Port Configuration** page will re-appear and will contain additional configuration settings specific to the profile you have chosen.

*For more information on these configuration options see the web-based Tutorial and online Help.*

## ***Basic Serial Settings***

Click the **Basic Serial Settings** menu bar on the **Serial Port Configuration** page to configure the ES1AWB's serial port **Baud Rate, Data Bits, Parity, Stop Bits** and **Flow Control** parameters. For all profiles except RealPort, the Basic Serial Settings configuration section allows you to set these parameters. When the RealPort profile is selected the serial port settings will be directed by the PC applications using the virtual COM port.

## ***Advanced Serial Settings***

Click the **Advanced Serial Settings** menu bar to access settings used to fine tune the serial port. Typically these setting will not need to be changed. Consult the web-based tutorial for more information if necessary.

---

# Configuring Alarms and Notification

The ES1AWB can be configured to generate alarms and send notification emails based on the occurrence of specific events. Events include the states of some RS-232 handshake (GPIO) lines and the detection of specified character patterns within the serial data stream. The **Alarms Configuration** page displays the current alarm settings and allows you to configure them. It contains two sections: **Alarm Notification Settings** and **Alarm Conditions**.

*Note: In the ES1AWB GPIO lines are permanently configured as RS-232 hardware handshake lines to support the standard RS-232 interface. Do not attempt to re-configure the settings in the GPIO section of the Web Configuration and Management Interface.*

## Alarm Notification Settings

The **Alarm Notification Settings** page provides a checkbox to enable alarm notifications. Text boxes are provided to enter the IP address of your SMTP mail server and the email address that will be placed in the **From** field of the email.

## Alarm Conditions

The **Alarm Conditions** page is a tabular listing of 32 alarms that can be configured. Table headings include **Enable** (a checkbox), **Alarm name/number**, **Type** of alarm, **Trigger** conditions, **SNMP Trap**, **Send to** address and **Email Subject** line.

Clicking on the Alarm name opens an **Alarm Configuration** page for that specific alarm. The page contains two sections: **Alarm Conditions** and **Alarm Destinations**.

**Alarm Conditions** allows you to select GPIO-based or serial data pattern-based events.

*GPIO is not supported in the ES1AWB but it is possible to use the **Send alarms based on GPIO pin states** feature to generate alarms based on the condition of some RS-232 hardware handshake lines. For assistance in implementing this feature contact B&B Electronics Technical Support.*

To **Send alarms based on serial data pattern matching**, select that option and type a character string into the text box provided.

## **Alarm Destinations**

**Alarm Destinations** allows you to specify where to send alarm notification emails, their priority and subject title. Type the information into the **Mail to** email address, **CC** address, set the *Priority* and type in the *Subject* line.

To send an SNMP trap, select **Send SNMP trap to following destination when alarm occurs** and type the destination IP address for the SNMP trap.

---

Manual Documentation Number: ESI AWBE-2907m pn7042-rev002

B&B Electronics Mfg Co Inc - 707 Dayton Rd - PO Box 1040 - Ottawa IL 61350 - Ph 815-433-5100 - Fax 815-433-5104 - [www.bb-elec.com](http://www.bb-elec.com)

B&B Electronics Ltd - Westlink Commercial Park - Oranmore, Galway, Ireland - Ph +353 91-792444 - Fax +353 91-792445 - [www.bb-europe.com](http://www.bb-europe.com)

## Chapter 6: Managing the ES1AWB

---

### System Settings

The **System** configuration page contains two sections: the **Device Identity Settings** and the **Simple Network Management Protocol (SNMP) Settings**.

#### **Device Identity Settings**

The **Device Identity Settings** page allows you to enter a **Description** such as the network name of the ES1AWB, the **SNMP Contact** person, a text description of the **Location** of the ES1AWB and the **Device ID** number.

#### **Simple Network Management Protocol (SNMP) Settings**

The **SNMP Settings** page allows you to enable and configure **SNMP** and **SNMP traps**.

*For more information on using **SNMP** access the **Tutorial and Help files** and/or request assistance from your network administrator.*

---

### Using Remote Management

The ES1AWB can be remotely managed using the **Connectware Manager**, a server installed on a separate computer. There are three sections to the **Remote Management Configuration** page: **Connections**, **Security** and **Advanced** settings.

*For more information on **Remote Management Configuration** click the **Connectware Manager Tutorial link**.*

---

### Managing Users and Permissions

The **Users** configuration page allows you to add, remove and edit **Users** information including passwords, access privileges and user permissions.

---

## Changing the Root Username and Password

You may want to change the Root username and password after you have gained access to the Web Configuration and Management Interface. To change your username and password click **Users** under the **Configuration** menu. Follow the prompts to enter a new username and password. Click **Apply** to complete the procedure.

## Adding New Users

The root user of the ES1AWB (using the default username and password), has complete administrative rights, including access and control of all configuration parameters. As administrator you can add other users and configure the specific rights of each.

Non-administrators can also set up new users, access and permissions (if they have permission) but a user cannot set another user's permission level higher than their own permission level, nor can a user raise their own permission level.

1. In the **Configuration** menu, click **Users**. The **User Configuration** page appears.
2. Click **New**. The **Add New User** page appears.
3. Type a new username in the **New Username** box.
4. Type a new password in the **New Password** box. The characters you type will be masked by asterisks.
5. Type the new password again in the **Confirm Password** box. The characters you type will be masked by asterisks.
6. Click **Apply**. After a short delay a message box appears at the top of the page announcing “**Changes have been saved successfully.**”

## Configuring User Access and Permissions

1. In the Configuration menu, click **Users**. The **User Configuration** page appears.
2. Click the username to be configured. The **User Configuration – Username** page appears. To change the username or password, make the changes under **User Configuration** and click **Apply**.

---

Manual Documentation Number: ES1AWBE-2907m pn7042-rev002

B&B Electronics Mfg Co Inc – 707 Dayton Rd - PO Box 1040 - Ottawa IL 61350 - Ph 815-433-5100 - Fax 815-433-5104 – [www.bb-elec.com](http://www.bb-elec.com)

B&B Electronics Ltd – Westlink Commercial Park – Oranmore, Galway, Ireland – Ph +353 91-792444 – Fax +353 91-792445 – [www.bb-europe.com](http://www.bb-europe.com)

3. Click the **User Access** link. The User Access page opens. Select **Allow command line access** and/or **Web Interface Access**. Click **Apply**. (See the online help for more information on these choices.)
4. Click the **User Permissions** link. The **User Permissions** page appears containing a list of permissions and dropdown lists. For each item on the list select the level of permission to be granted to the user. (See the online help for more information on these choices.)

## Managing Serial Ports and Connections

The Management section of the Web Configuration and Management Interface provides information about the current operational state of the ES1AWB.

### **Serial Ports**

The **Serial Port Management** page displays information on: **Port** number, **Description**, **Profile** and **Connections**. If you click **Connections** the Port Connections Management page appears displaying information on where the port is **Connected From**, **Connected To**, the **Protocol** (or profile) being used and the number of **Sessions**. This information can be **Refreshed** and, if the **Action** box is selected the **Disconnect** button becomes available, allowing you to disconnect.

### **Connections**

The **Connections Management** page displays network connections information including **Connected From**, **Connected To**, the **Protocol** in use and the number of **Sessions**.

---

Manual Documentation Number: ES1AWBE-2907m pn7042-rev002

B&B Electronics Mfg Co Inc - 707 Dayton Rd - PO Box 1040 - Ottawa IL 61350 - Ph 815-433-5100 - Fax 815-433-5104 - [www.bb-elec.com](http://www.bb-elec.com)

B&B Electronics Ltd - Westlink Commercial Park - Oranmore, Galway, Ireland - Ph +353 91-792444 - Fax +353 91-792445 - [www.bb-europe.com](http://www.bb-europe.com)

## Chapter 7: Using Administrative Features

---

For additional information on each of the following features access the Tutorial and Help files.

### File Management

The **File Management** page provides facilities to upload and/or manage custom web pages and files such as your applet and HTML files to the ES1AWB. Uploading an index.htm or index.html file will automatically load that page upon logging into the ES1AWB.

### Backup/Restore

The **Backup/Restore** page allows you to back up the current configuration settings on your ES1AWB to a folder on your PC. You can also restore the configuration from a saved file.

### Update Firmware

The Update Firmware page allows you to select firmware from a folder on your computer and upload it to the ES1AWB.

*Caution: When updating the firmware, check the support site and release notes for more information to determine if the ES1AWB must update the POST before updating the firmware.*

### Factory Default Settings

The Factory Default Settings page allows you to reset the ES1AWB to factory defaults (see Appendix A) with the option of keeping network settings as they are.

*Caution: Restoring the factory default settings will clear all current settings and automatically reboot the ES1AWB.*

---

# System Information

The **System Information** page displays information about your ES1AWB:

## **General**

- Model
- MAC Address
- Firmware Version
- Boot Version
- POST Version
- CPU Utilization
- Up Time
- Total Memory
- Used Memory
- Free Memory

## **GPIO**

Not applicable to the ES1AWB

## **Serial**

The **Serial** page displays a table containing the following information:

- Port number
- Description
- Profile
- Serial Configuration (baud rate, data bits, parity, stop bits)

If you click Port 1 the **Serial Port Diagnostics** page appears:

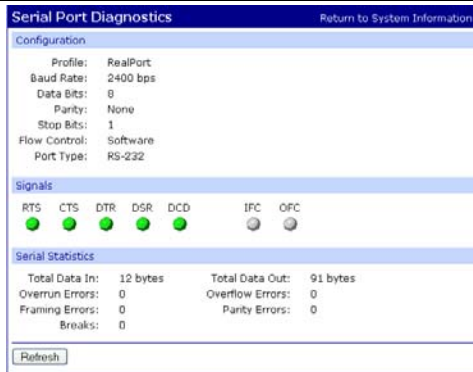

Figure 15. Serial Port Diagnostics Page

## Network

The Network page displays statistics related to **IP**, **TCP**, **UDP** and **ICMP** protocol activities.

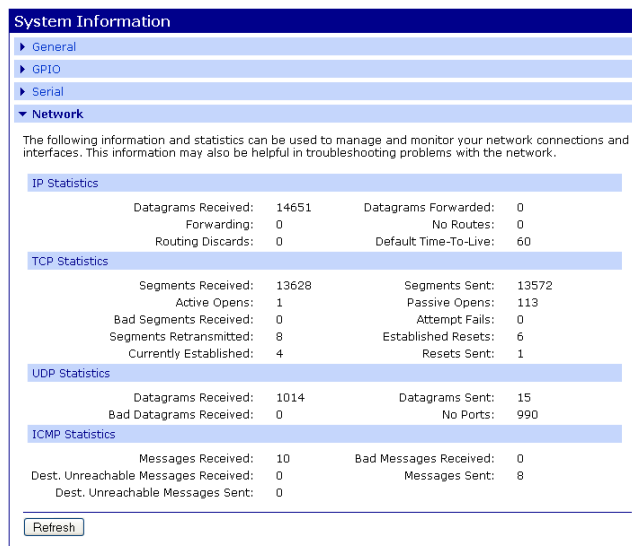

Figure 16. Network Information Page

## Reboot

The **Reboot** page allows you to reboot the ES1AWB. If you click on **Reboot** the process will take approximately one minute to complete.

---

## Chapter 8: Using RealPort

---

**RealPort** is a COM port redirector program that allows you to add and remove virtual COM ports on your PC and update the RealPort software.

Virtual COM ports allow you to set up a connection between your PC and the device connected to the serial port on your ES1AWB via an Ethernet network connection using TCP/IP. If you will be using virtual COM ports (configuring your serial port with the RealPort profile) you must use RealPort to configure those ports on your PC. Once you have configured a new virtual COM (VCOM) port using RealPort, application software can communicate through that COM port as if it is located within the PC.

There are three steps to setting up a virtual COM port with RealPort.

1. Configure the ES1AWB with an IP address
2. Configure the ES1AWB serial port for RealPort (VCOM) mode
3. Configure the port itself using RealPort

### **Configuring the IP Address**

See **Chapter 3, Configuring the IP Address**

### **Configuring the Serial Port for RealPort**

1. Login to the Web Configuration and Management Interface.
2. Select **Configuration, Serial Port**.
3. On the **Serial Port Configuration** page, check the **Profile** for the port. If it is not **RealPort**, click **Port 1**.
4. On the page that appears click **Change Profile**.
5. On the **Select Port Profile** page, select **RealPort**, then click **Apply**.

---

## ***Adding a Virtual COM Port using RealPort***

Windows 2000/XP/Vista:

1. Locate the RealPort driver software on the CD you received with your ES1AWB.
2. Find the RealPort setup.exe file for your PC's operating system.
3. Start the **setup.exe** file. The **RealPort Setup Wizard Welcome** dialog appears.
4. Select the **Add a New Device**, then click **Next**. The **Select Device** dialog appears listing the **IP Address**, **MAC Address** and **Model** of all devices on the network. To identify your ES1AWB compare the MAC address listed with the MAC address on the label on your ES1AWB.
5. Select the device to be configured as a virtual COM port and click **Next**.
6. In the **Select COM Port** dialog that appears, select the COM port number to be assigned to the ES1AWB. Click **Next**. A progress screen will appear.
7. When the process is complete click **Finish**.

Windows 98, ME, NT 4.0:

1. Follow the readme.txt included with each O/S on the CD (no setup.exe available).

## ***Removing a Virtual COM Port using RealPort***

Windows 2000/XP/Vista:

1. Locate the RealPort driver software on the CD you received with your ES1AWB.
2. Find the RealPort setup.exe file for your operating system.
3. Start the **setup.exe** file. The **RealPort Setup Wizard Welcome** dialog appears.

---

Manual Documentation Number: ES1AWBE-2907m pn7042-rev002

B&B Electronics Mfg Co Inc - 707 Dayton Rd - PO Box 1040 - Ottawa IL 61350 - Ph 815-433-5100 - Fax 815-433-5104 - [www.bb-elec.com](http://www.bb-elec.com)

B&B Electronics Ltd - Westlink Commercial Park - Oranmore, Galway, Ireland - Ph +353 91-792444 - Fax +353 91-792445 - [www.bb-europe.com](http://www.bb-europe.com)

4. Select the **Remove an Existing Device**, then click **Next**. The **Select Device to Remove** dialog appears listing the **IP Address**, **MAC Address** and **Model** of all devices on the network. To identify your ES1AWB compare the MAC address listed with the MAC address on the label on your ES1AWB.
5. Select the device to be removed and click **Next**.
6. In the **Select COM Port** dialog that appears, select the COM port number to be assigned to the ES1AWB. Click **Next**. A progress screen will appear.
7. When the process is complete click **Finish**.

Windows 98, ME, NT 4.0:

1. Follow the readme.txt included with each O/S on the CD (no setup.exe available).

### **Updating RealPort**

Windows 2000/XP/Vista:

1. Locate the RealPort driver software on the CD you received with your ES1AWB.
2. Find the RealPort setup.exe file for your operating system.
3. Start the **setup.exe** file. The **RealPort Setup Wizard Welcome** dialog appears.
4. Select the **Update RealPort Software**, then click **Next**.
5. A progress dialog will appear.
6. When the process is complete a dialog will indicate that you must restart your computer before the new settings will take effect. Click **Yes** to restart your computer now.

Windows 98, ME, NT 4.0:

1. Follow the readme.txt included with each O/S on the CD (no setup.exe available).

---

Manual Documentation Number: ESIWBE-2907m pn7042-rev002

B&B Electronics Mfg Co Inc - 707 Dayton Rd - PO Box 1040 - Ottawa IL 61350 - Ph 815-433-5100 - Fax 815-433-5104 - [www.bb-elec.com](http://www.bb-elec.com)

B&B Electronics Ltd - Westlink Commercial Park - Oranmore, Galway, Ireland - Ph +353 91-792444 - Fax +353 91-792445 - [www.bb-europe.com](http://www.bb-europe.com)

## Appendix A: Default Configuration Settings

Server Name	ES1AWB
Username:	root
Password:	dbps
DHCP:	Enabled
Baud Rate:	9600
Data//Stop:	8-1
Parity:	None
Flow Control:	None
TCP/UDP Protocol:	TCP
Connection Mode:	TCP Socket
TCP/UDP port:	2001

Manual Documentation Number: ES1AWBE-2907m pn7042-rev002

B&B Electronics Mfg Co Inc - 707 Dayton Rd - PO Box 1040 - Ottawa IL 61350 - Ph 815-433-5100 - Fax 815-433-5104 - [www.bb-elec.com](http://www.bb-elec.com)  
B&B Electronics Ltd - Westlink Commercial Park - Oranmore, Galway, Ireland - Ph +353 91-792444 - Fax +353 91-792445 - [www.bb-europe.com](http://www.bb-europe.com)

---

Manual Documentation Number: ESIWBE-2907m pn7042-rev002

B&B Electronics Mfg Co Inc - 707 Dayton Rd - PO Box 1040 - Ottawa IL 61350 - Ph 815-433-5100 - Fax 815-433-5104 - [www.bb-elec.com](http://www.bb-elec.com)

B&B Electronics Ltd - Westlink Commercial Park - Oranmore, Galway, Ireland - Ph +353 91-792444 - Fax +353 91-792445 - [www.bb-europe.com](http://www.bb-europe.com)

## Appendix B: Product Specifications

Model:	ES1AWB
Manual:	Paper copy of this manual, PDF available
CD-ROM disk:	RealPort virtual COM port software for Windows 98/ME/2000/XP/NT 4.0/Vista B&B discovery software (finder.exe) PDF of ES1AWB User Manual PDF of Quick Start guide
Operating Systems Supported:	Windows 98/ME/2000/XP/NT 4.0/Vista (call B&B Technical Support for other operating systems)
Dimensions	2.1 x 3.0 x 3.34 in (5.3 x 7.6 x 8.5 cm) without antenna
Power Supply Requirements:	5VDC 500mA min via 5.5mm by 2.1mm barrel jack tip positive
Power Consumption:	2.5 W maximum
Operating Temperature:	0 to 70 °C (32 to 158 °F)
Storage Temperature:	-40 to 85 °C (-40 to 185 °F)
Humidity:	10% to 90% R.H. non-condensing
Approvals:	CE, FCC Class A
Link Integrity Indicator:	Yellow LED
Activity Indicator:	Green LED
Ethernet Standards Supported:	IEEE 802.11b wireless networking
Frequency:	2.4 GHz
Data rate:	11, 5.5, 2, 1 Mbps with automatic fallback
Modulation:	CCK (11/5 Mbps), DQPSK (2 Mbps), DBPSK (1 Mbps)
Transmit power:	16 dBm typical
Receive sensitivity:	-82 dBm @ 11 Mbps -87 dBm @ 5.5 Mbps -89 dBm @ 2 Mbps -92 dBm @ 1 Mbps
Channels:	11 (USA/Canada), 13 (Europe), 14 (Japan)
Antenna connector:	1 x RP-SMA, omni-directional (included)
Protocols Supported:	TCP, UDP, DHCP, SNMP, SSL/TLS, TELNET, RLOGIN, RFC 2217, LPD, HTTP/HTTPS, SMTP, ICMP, IGMP, ARP

Manual Documentation Number: ES1AWBE-2907m pn7042-rev002

B&B Electronics Mfg Co Inc - 707 Dayton Rd - PO Box 1040 - Ottawa IL 61350 - Ph 815-433-5100 - Fax 815-433-5104 - [www.bb-elec.com](http://www.bb-elec.com)  
B&B Electronics Ltd - Westlink Commercial Park - Oranmore, Galway, Ireland - Ph +353 91-792444 - Fax +353 91-792445 - [www.bb-europe.com](http://www.bb-europe.com)

Serial Connector:	9 pin D-type male (DB-9M)
RS-232 Interface Lines Supported:	TD, RD, RTS, CTS, DTR, DSR, DCD, DSR, GND
Serial Data Rates:	50, 75, 110, 134, 150, 200, 300, 600, 1200, 1800, 2400, 4800, 9600, 14400, 19200, 28800, 38400, 57600, 115200, 230400 bps
Parity:	None, Even, Odd, Mark, Space
Data Bits:	5, 6, 7 or 8
Stop Bits:	1 or 2
Flow control:	None, Hardware, Software
Set-up Options:	Web Configuration and Management Interface
Configuration Modes:	Direct IP (TCP or UDP Sockets) Virtual COM Port (RealPort) Paired Mode (serial bridge/serial tunneling) Modem Emulation Custom
Configuration Method:	Uses any web browser via built-in web server Customizable web interface option with support for Java applets
Security:	Admin configuration password protection WEP (Wired Equivalent Privacy) - 64/128-bit encryption (RCA) WPA (Wireless Protected Access) - 128-bit TKIP encryption - 802.1x EAP authentication PEAP (Protected EAP) w/EAP-MS-CHAPv2 Pre-shared key mode (PSK) Strong SSL v3.0 / TLS v1.0 based encryption – DES (56 bit), 3DES (168 bit), AES (128/256 bit)
Device Management:	SNMP – RFC 1213/1215/1316/131
IP Address Assignment:	Static IP, DHCP, Auto-IP
TCP/UDP Forwarding Characteristics:	Bytes, Idle Time, Data Pattern
Event Notification:	Via email with SNMP traps triggered by matching data pattern
Accessories:	5VDC 1200mA power supply.

Manual Documentation Number: ES1AWBE-2907m pn7042-rev002

B&B Electronics Mfg Co Inc – 707 Dayton Rd - PO Box 1040 - Ottawa IL 61350 - Ph 815-433-5100 - Fax 815-433-5104 – [www.bb-elec.com](http://www.bb-elec.com)

B&B Electronics Ltd – Westlink Commercial Park – Oranmore, Galway, Ireland – Ph +353 91-792444 – Fax +353 91-792445 – [www.bb-europe.com](http://www.bb-europe.com)

# Appendix C: ES1AWB Dimensional Diagram

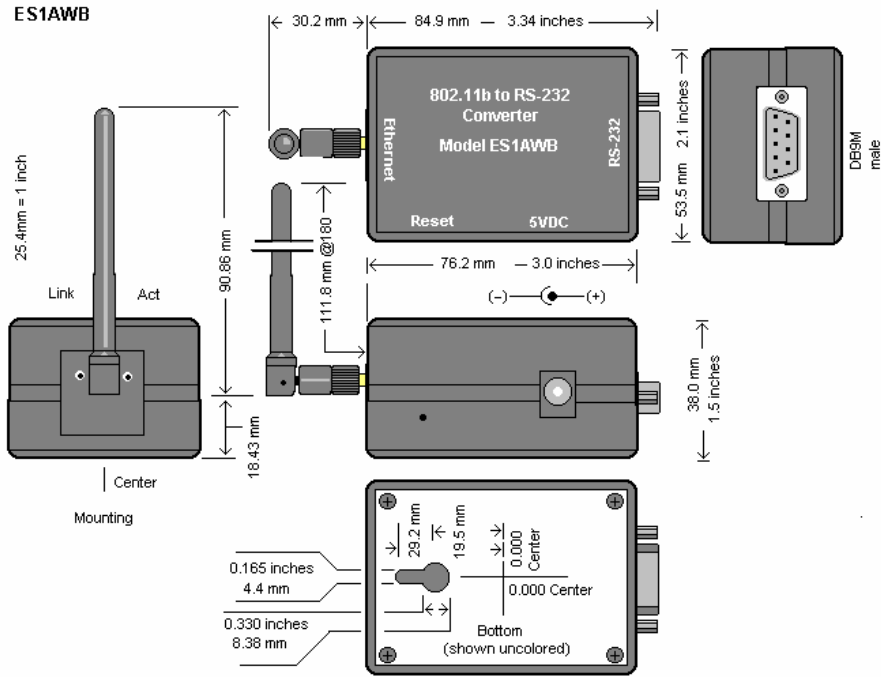

Figure 17. Dimensional Diagram of the ES1AWB

---

Manual Documentation Number: ES1AWBE-2907m pn7042-rev002

B&B Electronics Mfg Co Inc - 707 Dayton Rd - PO Box 1040 - Ottawa IL 61350 - Ph 815-433-5100 - Fax 815-433-5104 - [www.bb-elec.com](http://www.bb-elec.com)

B&B Electronics Ltd - Westlink Commercial Park - Oranmore, Galway, Ireland - Ph +353 91-792444 - Fax +353 91-792445 - [www.bb-europe.com](http://www.bb-europe.com)

# Appendix D: RS-232 Connections

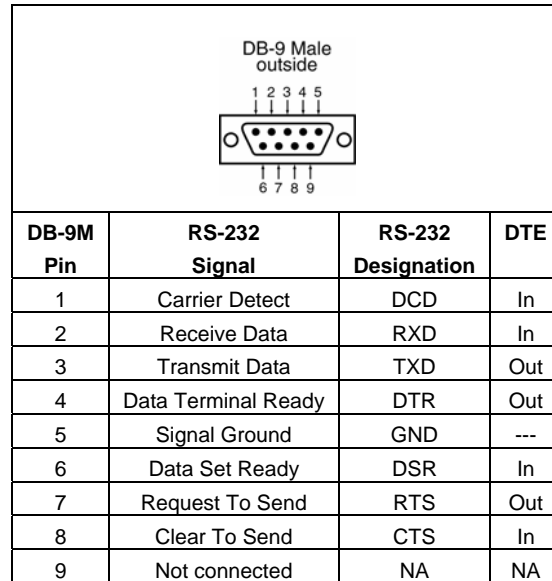



Figure 18. RS-232 Connections in a DB-9 Connector

**DECLARATION OF CONFORMITY**

Manufacturer's Name: B&B Electronics Manufacturing Company  
 Manufacturer's Address: P.O. Box 1040  
 707Dayton Road  
 Ottawa, IL 61350 USA

Model Numbers: ES1AWBE  
 Description: 802.11b Wireless Serial Server  
 Type: Light industrial ITE equipment  
 Application of Council Directive: 89/336-EEC  
 Standards: EN 55022  
 EN 61000-6-1  
 EN 61000 (-4-2, -4-3, -4-4, -4-5, -4-6, -4-8, -4-11)



Michael J. Fahrion, Director of Engineering

**CE**