

Zlinx Radio Modem

ZP Series

Documentation Number: ZP9D-115RM-LR-2508
pn#7697R2

*This product designed and manufactured in Ottawa, Illinois USA
of domestic and imported parts by*



707 Dayton Road -- P.O. Box 1040 -- Ottawa, IL 61350 USA
Phone (815) 433-5100 -- General Fax (815) 433-5105

Phone (815) 433-5100 -- **General Fax** (815) 433-5105

Website: www.bb-elec.com

European Headquarters

B&B Electronics

Westlink Commercial Park -- Oranmore, Co. Galway, Ireland

Phone +353 91-792444 -- **Fax** +353 91-792445

Website: www.bb-europe.com

B&B Electronics Mfg. Co. Inc. -- June 2008

This document contains information that is proprietary and confidential to B&B Electronics Mfg. Co. Inc. The methods described herein are for the exclusive use of B&B Electronics authorized personnel. Any unauthorized use or dissemination of the information contained in the document is strictly forbidden.

Table of Contents

Introduction	4
PACKAGE CONTENTS	4
Hardware Installation	5
DIP SWITCH SETTINGS	5
MOUNTING AND POWER	5
SERIAL CONNECTIONS	6
RS-232	6
RS-422/485	7
WIRELESS LINK FAILURE OUTPUT	8
RADIO FREQUENCY INFORMATION	8
Zlinx Manager Software	10
INSTALLATION	10
SET UP	10
ON-LINE CONFIGURATION	12
TEST / TROUBLESHOOT	16
FIRMWARE UPDATE	18
Specifications	19
Special Consideration for Class 1 DIV 2	21
Advanced Programming	22
AT COMMANDS	22
BINARY COMMANDS	23
COMMAND REFERENCE TABLE	24
ZLINX COMMANDS (ZLINX RADIO MODEMS EXPECT NUMERICAL VALUES IN HEXADECIMAL. HEXADECIMAL VALUES ARE DESIGNATED BY A "0X" PREFIX. DECIMAL EQUIVALENTS ARE DESIGNATED BY A "D" SUFFIX.)	24
COMMAND DESCRIPTIONS	28

Introduction

Easy to install, up to 14 mile range No wires, no cables! Zlinx radio modems get your data moving farther, easier, and at less cost than running cable. Plug-n-play, Modbus compatible, signal strength indicator, space saving DIN rail mounting. Heavy-duty, wide temperature design handles most industrial power configurations and tough indoor/outdoor environments.



Model #	Frequency	Radio Power	RF Data Rate
ZP9D-115RM-LR	900MHz	Configurable 1 mW to 1W	Configurable 9600 bps or 115Kbps

Package Contents

- Radio Modem
- Antenna
- Software CD
- Manual on CD

Will require separate 18-30VAC or 10-48VDC Power Supply

ZP9D-115RM-LR = 5.0W max

Hardware Installation

Dip Switch Settings

Dipswitch	OFF	ON
1	4-wire	2-wire
2	4-wire	2-wire
3	No termination	Termination
4	RS-422	RS-485



Mounting and Power

- Install on properly grounded DIN rail
 - Operating Temperature is -40 to 85
 - Operating Humidity is 10-90% non-condensing
- Connect Power Supply
 - Power supply is 10-48 VDC or 18-30 VAC

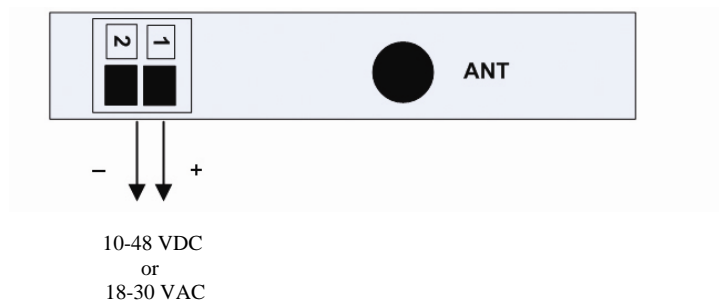

Serial Connections

RS-232

RS-232 Always present on DB9

Wiring Terminal Identification		
DB9F Pin	Signal Name	Direction
1	Data Carrier Detect	Out
2	Receive Data	Out
3	Transmit Data	In
4	Data Terminal Ready	In
5	Signal Ground	---
6	Data Set Ready	Out
7	Request To Send	In
8	Clear To Send	Out
9	Not used	---

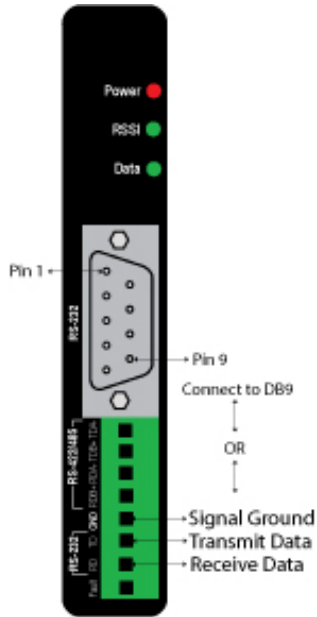

Note: The DTR input is used to put the radio into sleep mode. The radio sleep option must be enabled first using the configuration software. Once enabled, lowering the DTR signal will put the radio in sleep mode and raising the DTR signal will put the radio in idle mode, ready to receive or transmit data.

RS-422/485

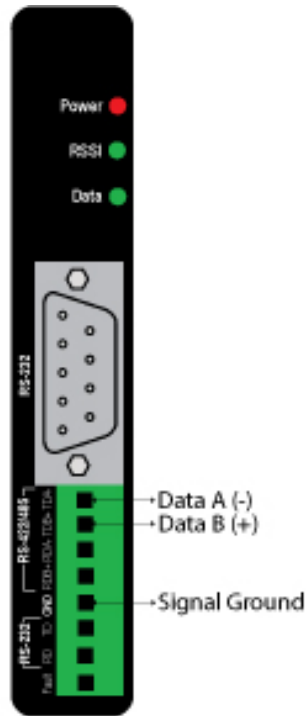

RS-485 (2Wire)

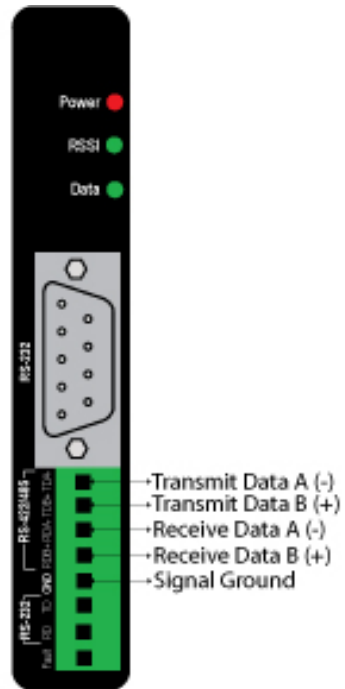

RS-422/485 (4Wire)

Wireless Link Failure Output

- Zlinx Radio modems offer a source (PNP)transistor output when the wireless signal strength drops below a critical level (link failure or miss packets)
- 40 mA max current

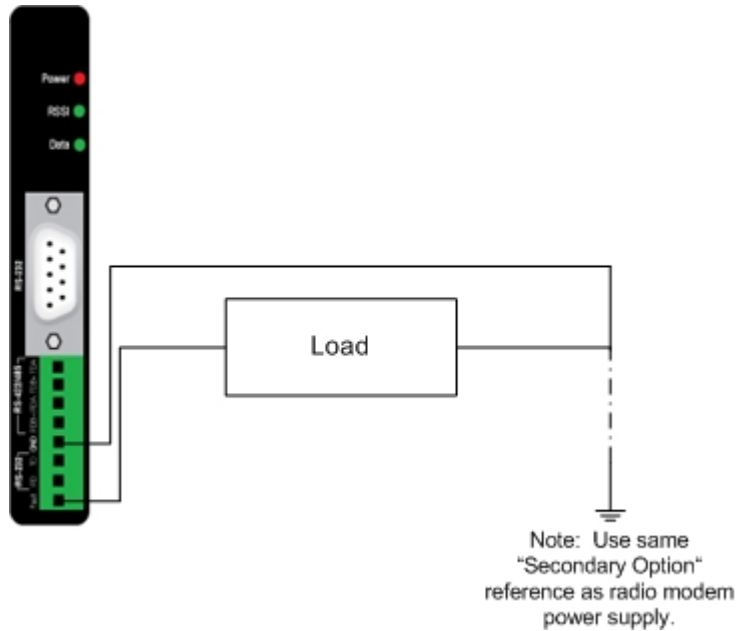

Note: In order for the RSSI LED to continuously indicate the signal strength, set the RP command (RSSI PWM timer) to FF.

Radio Frequency Information

- The ZP9D-115RM-LR has an indoor range of up to 3000 feet and an outdoor range of up to 14 miles.
- These ranges are for line of sight installations using the supplied antenna. Performance may vary depending on your particular installation.
- The antenna connection on the radio modem is an RPSMA female plug.
- B&B Electronics has a wide variety of accessory antennas. Visit www.bb-elec.com for more information.

Model #	Frequency	Radio Power	RF Data Rate
ZP9D-115RM-LR	900MHz	1mW to 1W (selectable)	9600 bps to 115Kbps

Zlinx Manager Software

Installation

- The Zlinx Manager Software is contained CD.
- Insert the CD into the drive.
- The installation program should auto start.
- Follow the on screen prompts.

Set Up

1. Connect your PC to the modem using a straight through serial cable.
2. Start the Zlinx Manage Software and click on the radio modem button.



3. The radio modem launcher screen will appear



3. Click on the Radio Modem Configuration button to configure the modem on-line or the Radio Modem Configuration Button (offline) to configure the modem offline. Follow the on screen directions to configure the modem. Note: using the off-line configuration button skips the auto modem discovery process.

On-Line Configuration

1. Click the Radio Modem Configuration Button. The following screen will appear.

The screenshot shows a configuration window for a radio modem. The window title is "Zlinx Manager V2.0.0 - Zlinx Radio Modem". At the top, there is a logo for "B&B electronics MANUFACTURING COMPANY". Below the logo, there are several configuration options, each with a pull-down menu:

- Model: ZP24D-192RM-MR
- Comm. Port: 5
- Baud: 9600
- Data Bits: 8 Bits
- Parity: None
- Stop Bit: 1 Bit

At the bottom of the window, there are four buttons with icons and text labels:

- Connect (with a modem icon)
- Auto Modem Search (with a modem icon)
- Advanced Command (with a key icon)
- Return Main (with a left-pointing arrow icon)

2. Use the pull down menu items to set up the communication parameters.

3. Click the Auto Modem Search button. The Zlinx Manager software will find the radio modem. If the modem is not found, the following screen will appear.

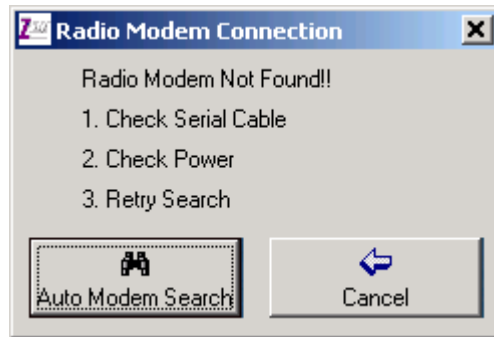

4. When the modem is found, the following screen will appear.

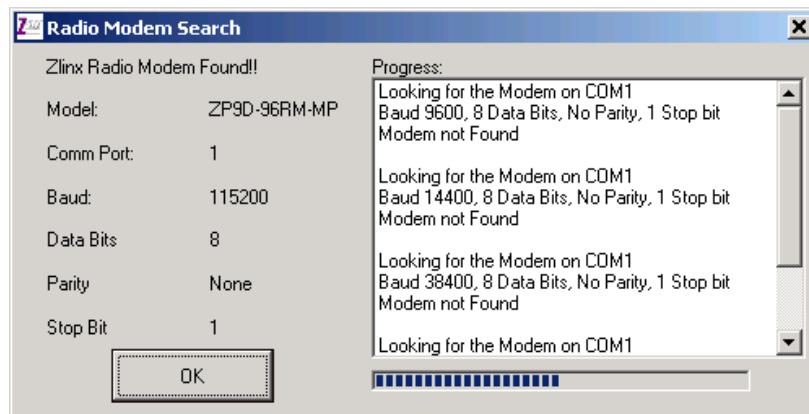

5. Click OK. The following screen will appear.

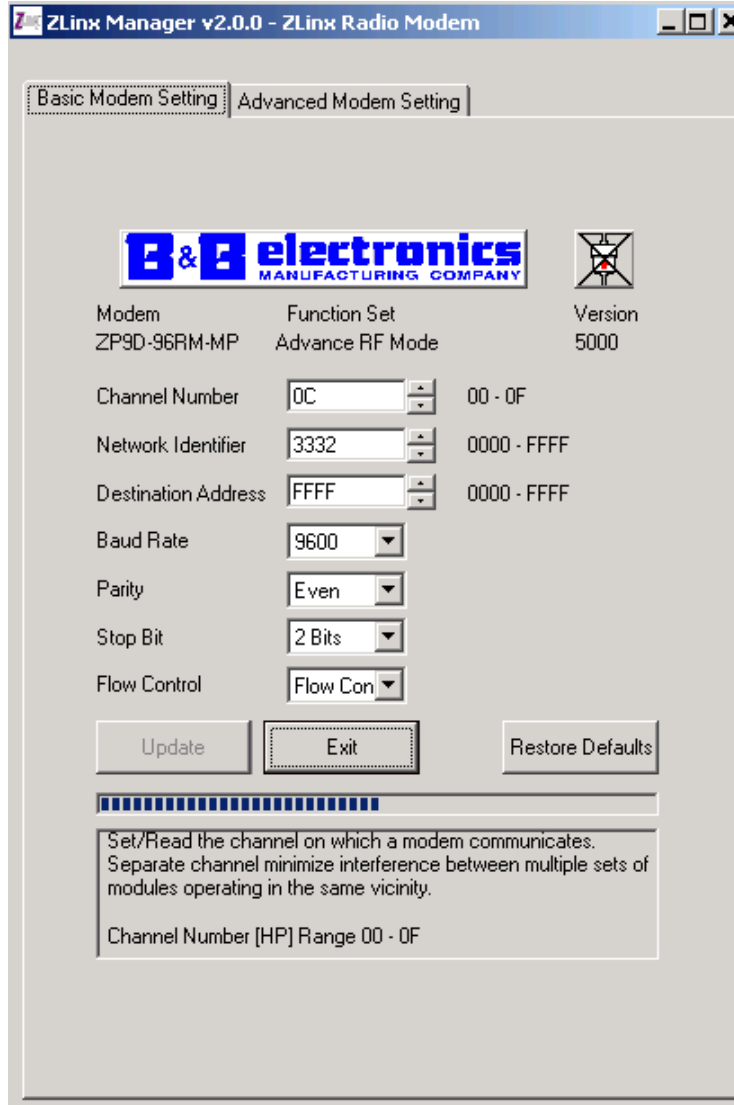

5. On the Basic Modem setting tab, configure a unique channel number, network identifier, and destination address. This will prevent interference from other modems. Click the Update button to save the parameters. Click the Restore Defaults button to revert to the default configuration.

6. Use the advanced tab to configure additional parameters. When each option is highlighted, the text box will display an explanation of the command and the associated hex range. Click the update button to save the parameters. Click the Restore Defaults button to revert to the default configuration.

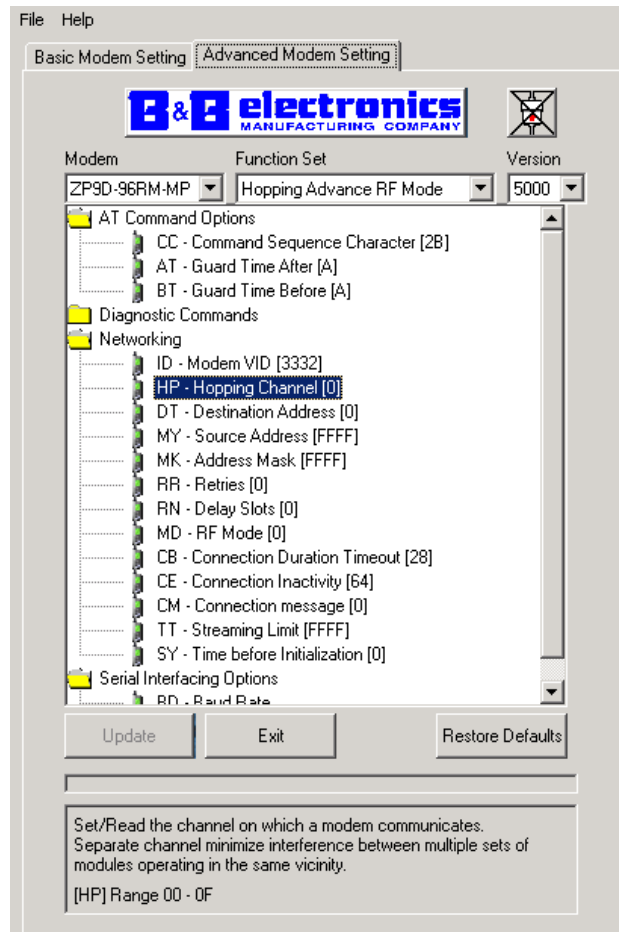

Test / Troubleshoot

1. The RSSI Range Test allows you test your installation. Cross connect TD and RD on the remote modem before running the test.

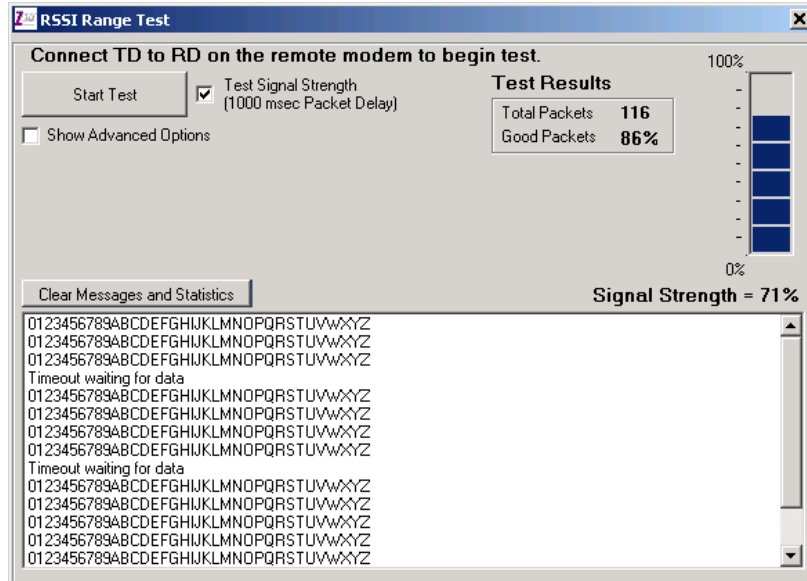

2. The basic screen shows test results and signal strength. Check the Show Advanced Option Box to customize the test.

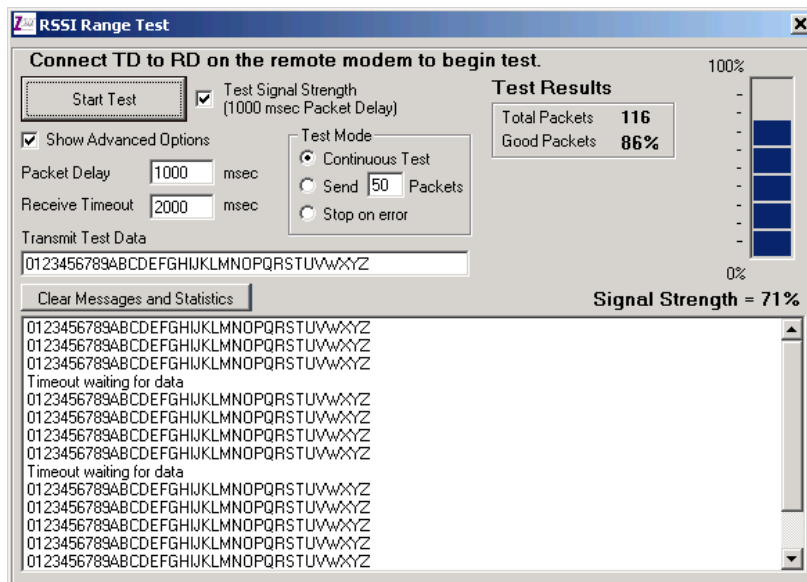

Firmware Update

1. Connect your PC to the radio modem using a straight through serial cable and the auto connect function. The new firmware must be stored on the PC's local drive.
2. From the Zlinx Manager Radio Modem launch screen, click the firmware update button.
3. Once connected, the software will determine which firmware versions are available on the PC and what version is loaded in the modem. The following screen allows you to chose which firmware version to load.



4. Select the firmware version to load from the pull down menu and click the update button.

Specifications

RF Properties	
Physical Standard	Proprietary radio
Range	up to 3000 feet indoor or 14 miles outdoor
Frequency	900MHz
Transmit Power	1W (selectable)
Software	
Support	Windows 2000, 2003 Server, XP, and Vista
Features	AT Command Terminal emulation RSSI signal range test Modem emulation
Antenna Options	
	External Reverse Polarity SMA male jack connector, omni directional (included with product)
Radio Address	
	Defaulted at factory, set by software otherwise
Serial settings	
Baud	1200, 2400, 4800, 9600, 19200, 38400, 57600, 115200, 230400
Data bit	7, 8
Parity	None, even, odd, mark, space
Stop bit	1, 2
RS-232	
Connector	DB9F DCE
Lines	TX, RX, RTS, CTS, DTR, DSR, DCD, RI, GND
Connector	Removable terminal block
Lines	TX, RX, GND
RS-422	
Connector	Removable terminal block
Lines	2 or 4 wire – TX+, TX-, RX+, RX-, GND (2 or 4 wire dipswitch selectable)
Termination	120 Ohm Dipswitch selectable
RS-485	
Connector	Removable terminal block
Lines	2 or 4 wire with SD control – TX+, TX-, RX+, RX-, GND (2 or 4 wire dipswitch selectable)
SD control	Bit wise
Termination	120 Ohm Dipswitch selectable
Transistor link failure	
	No wireless signal or RSSI LED off
Connector	Removable terminal block with RS-422/485
Output type	Open collector, dry contact, 40mA
Power Supply	
Connector	Removable terminal block
Input Voltage	10–48VDC, 18-30VAC

Power Consumption	5.0W max	
Dimensions	1.2W x 3.3D x 4.7H	
Environmental	Intended for indoor use only	
Operating Temperature	-40 to 85°C (-40 to 185°F)	
Storage Temperature	-40 to 85°C (-40 to 185°F)	
Operating Humidity	10 to 90% non-condensing	
Enclosure Rating		
Rating	IP30	
Mounting	DIN rail mount, 35mm	
LED Status	Front Panel LED	Status
	Power	Red = On OFF = No Power
	RSSI (Signal Strength)	Green = Strong Yellow = OK Red = Weak OFF = No Signal
	Wireless Data	Green = Blink on with data
	Note: In order for the RSSI LED to continuously indicate the signal strength, set the RP command (RSSI PWM Timer) to FF.	
Wiring	(Copper Wire Only)	
Size / Type	28 to16 AWG / SOLID COPPER	
Temperature Rating	105 °C (221 °F) Minimum	
Terminal Torque	0.2 Nm (Newton-meters)	
Certifications		
FCC	FCC Part 15 Class B	
CE	CISPR (EN55022) Class B	
	EN61000-6-1 Generic Standards for Residential, Commercial, & Light Industrial	
	EN61000-4-2 ESD	
	EN61000-4-3 RFI	
	EN61000-4-4 EFT	
	EN61000-4-5 Surge	
	EN61000-4-6 CI	
	EN61000-4-8 Power Frequency Magnetic	
	EN61000-4-11 Voltage Dips & Interruptions	
UL	UL, cUL, Class 1 Div 2	
RoHS directive (lead free)	Yes	

Special Consideration for Class 1 DIV 2

Special Instructions for Installation and Operation in a Class 1 Div 2 Environment

When this device is operated in a Class 1 Div 2 environment, the following PRECAUTIONS and WARNINGS must be observed:

1. Power, input and output (I/O) wiring must be in accordance with Class 1 Division 2 wiring methods [Article 501.10(B) of the National Electrical Code, NFPA 70] and in accordance with the authority having jurisdiction.
2. WARNING – EXPLOSION HAZARD – SUBSTITUTION OF COMPONENTS MAY IMPAIR SUITABILITY FOR CLASS 1, DIVISION 2.
3. WARNING – EXPLOSION HAZARD – WHEN IN HAZARDOUS LOCATIONS, TURN OFF POWER BEFORE REPLACING OR WIRING MODULES.
4. WARNING – EXPLOSION HAZARD – DO NOT DISCONNECT EQUIPMENT UNLESS POWER HAS BEEN SWITCHED OFF OR THE AREA IS KNOWN TO BE NON-HAZARDOUS.
5. WARNING – THIS APPARATUS IS SUITABLE FOR USE IN CLASS 1, DIVISION 2, GROUPS A, B, C, AND D, OR UNCLASSIFIED LOCATIONS.

Advanced Programming

AT Commands

Example: Using Hyper Terminal Software to change the module's DT (Destination Address) parameter and save the new address to non-volatile memory. A serial connection to a PC is required.

Method 1 (One line per command)

Send AT Command	System Response
+++	OK <CR> (Enter into Command Mode)_
ATDT <Enter>	{current value} <CR> (Read Destination Address)_
ATDT1A0D <Enter>	OK <CR> (Modify Destination Address)_
ATWR <Enter>	OK <CR> (Write to non-volatile memory)_
ATCN <Enter>	OK <CR> (Exit Command Mode)

Method 2 (Multiple commands on one line)

Send AT Command	System Response
+++	OK <CR> (Enter into Command Mode)
ATDT <Enter>	{current value} <CR> (Read Destination Address)
ATDT1A0D,WR,CN <Enter>	OK <CR> (Execute commands)

Note: When using hyper terminal to program a modem, PC com port settings must match the baud (interface data rate), parity & stop bits parameter settings of the module.

Note: Do not send commands to the module during flash programming (when parameters are being written to the module registry).

Wait for the OK sys tem response that follows the ATWR command before entering the next command or use flow control.

Binary Commands

To Send Binary Commands:

Example: Use binary commands to change the RF module's destination address to 0x1A0D and save the new address to non-volatile memory.

1. RT Command must be set to '1' in AT Command Mode to enable binary programming.
2. Assert CMD (Pin 10 is driven high). (Enter Binary Command Mode)
3. Send Bytes [parameter bytes must be 2 bytes long]:
 - 00 (Send DT (Destination Address) Command)
 - 0D (Least significant byte of parameter bytes)
 - 1A (Most significant byte of parameter bytes)
 - 08 (Send WR (Write) Command)
4. De-assert CMD (pin 10 is driven low). (Exit Binary Command Mode)

Note: CTS (pin 9) is high when a command is being executed. Hardware flow control must be disabled as CTS will hold off parameter bytes.

Command Reference Table

Zlinx Commands

(Zlinx Radio Modems expect numerical values in hexadecimal. Hexadecimal values are designated by a “0x” prefix. Decimal equivalents are designated by a “d” suffix.)

AT _ Command	Binary _ Command	AT Command Name	Parameter Range	Command _ Category	# Bytes Returned	Factory Default
%V	0x3B (59d)	Board Voltage	0x2CCCA - 0x5BFFA [read-only]	Diagnostics	4	--
AM	0x40 (64d)	Auto-set MY	--	Networking & Security	--	--
AP v2.x20*	--	API Enable	0 - 2	Serial Interfacing	1	0
AT	0x05 (5d)	Guard Time After	2 - (ATST-3) [x 100 msec]	Command Mode Options	2	0x0A (10d)
BD	0x15 (21d)	Interface Data Rate	0 - 8 (standard rates) 0x39 - 0x1C9C38 (non-standard rates)	Serial Interfacing	4	3
BR	0x39 (57d)	RF Data Rate	0 - 1	RF Interfacing	1	1
BT	0x04 (4d)	Guard Time Before	0 - 0xFFFF [x 100 msec]	Command Mode Options	2	0x0A (10d)
CC	0x13 (19d)	Command Sequence Character	0x20 - 0x7F	Command Mode Options	1	0x2B [“+”] (43d)
CD	0x28 (40d)	GPO2 Configuration	0 - 4	Serial Interfacing	1	2
CF	--	Number Base	0 - 2	Command Mode Options	1	1
CN	0x09 (9d)	Exit Command Mode	--	Command Mode Options	--	--
CS	0x1F (31d)	GPO1 Configuration	0 - 4	Serial Interfacing	1	0
CT	0x06 (6d)	Command Mode Timeout	2 - 0xFFFF [x 100 ms]	Command Mode Options	2	0xC8 (200d)
DB	0x36 (54d)	Received Signal Strength	0x6E - 0x28 [read-only]	Diagnostics	2	--
DT	0x00 (0d)	Destination Address	0 - 0xFFFF	Networking & Security	2	0
E0	0x0A (10d)	Echo Off	--	Command Mode Options	--	--

E1	0x0B (11d)	Echo On	--	Command Mode Options	--	--
ER	0x0F (15d)	Receive Error Count	0 - 0xFFFF	Diagnostics	2	0
FH	0x0D (13d)	Force Wake-up Initializer	--	Sleep (Low Power)	--	--
FL	0x07 (7d)	Software Flow Control	0 - 1	Serial Interfacing	1	0
FS	0x3E (62d)	Forced Sync Time	0 - 0xFFFF	[x 10 msec] RF Interfacing	2	0
FT	0x24 (36d)	Flow Control Threshold	0 - (DI buffer size - 0x11) [Bytes]	Serial Interfacing	2	DI buffer size minus 0x11
GD	0x10 (16d)	Receive Good Count	0 - 0xFFFF	Diagnostics	2	0
HP	0x11 (17d)	Hopping Channel	0 - 9	Networking & Security	1	0
HT	0x03 (3d)	Time before Wake-up Initializer	0 - 0xFFFF	[x 100 msec] Sleep (Low Power)	2	0xFFFF (65535d)
HV	--	Hardware Version	0 - 0xFFFF [read-only]	Diagnostics	2	--
ID	0x27 (39d)	Modem VID	0x11 - 0x7FFF (user-settable) 0x8000 - 0xFFFF (factory-set, read-only)	Networking & Security	2	0x3332 (13106d)
KY	0x3C (60d)	AES Encryption Key	0 - (Any other 64-digit hex valid key)	Networking & Security	2	0
LH	0x0C (12d)	Wake-up Initializer Timer	0 - 0xFF [x 100 msec]	Sleep (Low Power)	1	1
MD v2.x20*	0x31 (49d)	RF Mode	0 - 6	Networking & Security	1	0
MK	0x12 (18d)	Address Mask	0 - 0xFFFF	Networking & Security	2	0xFFFF (65535d)
MT	0x3D (61d)	Multi-Transmit	0 - 0xFF	Networking & Security	1	0
MY	0x2A (42d)	Source Address	0 - 0xFFFF	Networking & Security	2	0xFFFF (65535d)
NB	0x23 (35d)	Parity	0 - 4	Serial Interfacing	1	0
PB v2.x20*	0x45 (69d)	Polling Begin Address	0 - 0xFFFF	Networking & Security	2	0
PD v2.x20*	0x47 (71d)	Minimum Polling Delay	0 - 0xFFFF _ (Base: (x 1 ms), Remote: [x 10 ms])	Networking & Security	2	0

ZP9D-115RM-LR Commands (Zlinx Radio Modems expect numerical values in hexadecimal. Hexadecimal values are designated by a "0x" prefix. Decimal equivalents are designated by a "d" suffix.)

AT _ Command	Binary _ Command	AT Command Name	Parameter Range	Command _ Category	# Bytes Returned	Factory Default
PE v2.x20*	0x46 (70d)	Polling End Address	0 - 0xFFFF	Networking & Security	2	0
PK	0x29 (41d)	Maximum RF Packet Size	1 - 0x800 [Bytes]	RF Interfacing	2	varies
PL	0x3A (58d)	TX Power Level	0 - 4	RF Interfacing	1	4 (1 Watt)
PW	0x1D (29d)	Pin Wake-up	0 - 1	Sleep (Low Power)	1	0
RB	0x20 (32d)	Packetization Threshold	1 - Current value of PK	Serial Interfacing	2	0x800 (2048d)
RC	--	Ambient Power - Single Channel	0 - 0x31 [dBm, read-only]	Diagnostics	1	--
RE	0x0E (14d)	Restore Defaults	--	(Special)	--	--
RM	--	Ambient Power - All Channels	No parameter - 0x7D0	Diagnostics	2	--
RN	0x19 (25d)	Delay Slots	0 - 0xFF [slots]	Networking & Security	1	0
RO	0x21 (33d)	Packetization Timeout	0 - 0xFFFF [x UART character time]	Serial Interfacing	2	3
RP	0x22 (34d)	RSSI PWM Timer	0 - 0xFF [x 100 msec]	Diagnostics	1	0x20 (32d)
RR	0x18 (24d)	Retries	0 - 0xFF	Networking & Security	1	0x0A (10d)
RT	0x16 (22d)	GPI1 Configuration	0 - 2	Serial Interfacing	1	0
SB	0x37 (55d)	Stop Bits	0 - 1	Serial Interfacing	1	0
SH	0x25 (37d)	Serial Number High	0 - 0xFFFF [read-only]	Diagnostics	2	varies
SL	0x26 (38d)	Serial Number Low	0 - 0xFFFF [read-only]	Diagnostics	2	varies
SM	0x01 (1d)	Sleep Mode	0 - 8 (3 is reserved)	Sleep (Low Power)	1	0
ST	0x02 (2d)	Time before Sleep	(ATAT+3) - 0x7FFF [x 100]	Sleep (Low Power)	2	0x64 (100d)

			msec]			
TP	0x38 (56d)	Board Temperature	0 - 0x7F [read-only]	Diagnostics	1	--
TR	0x1B (27d)	Delivery Failure Count	0 - 0xFFFF [read-only]	Diagnostics	2	0
TT	0x1A (26d)	Streaming Limit	0 - 0xFFFF [0 = disabled]	Networking & Security	2	0
TX	0x3F (63d)	Transmit Only	0 - 1	RF Interfacing	1	0
VL	--	Firmware Version - verbose	Returns string	Diagnostics	--	--
VR	0x14 (20d)	Firmware Version	0 - 0xFFFF [read-only]	Diagnostics	2	--
WA	--	Active Warning Numbers	Returns string	Diagnostics	--	--
WN	--	Warning Data	Returns string	Diagnostics	--	--
WR	0x08 (8d)	Write	--	(Special)	--	--
WS	--	Sticky Warning Numbers	Returns string	Diagnostics	--	--

* Firmware version in which command and parameter options were first supported

Command Descriptions

Commands in this section are listed alphabetically. Command categories are designated between the "< >" symbols that follow each command title. By default, Zlinx Radio Modems expect numerical values in hexadecimal since the default value of the CF (Number Base) Parameter is '1'. Hexadecimal values are designated by the "0x" prefix and decimal values by the "d" suffix.

%V (Board Voltage) Command

<Diagnostics> %V Command is used to read the current voltage of the module circuit board.

AT Command: AT%V

Binary Command: 0x3B (59 decimal)

Parameter Range (read-only): 0x2CCCA - 0x5BFFA (2.80 - 5.75 decimal)

Sample Output:

5.02 V (when ATCF = 0)

5051F (when ATCF = 1) *

5.02 (when ATCF = 2)

Number of bytes returned: 4

* When CF = 1 (default), a hex integer is shown that is equal to (voltage * 65536d).

AM (Auto-set MY) Command

<Networking & Security> AM Command is used to

AT Command: ATAM

Binary Command: 0x40 (64 decimal)

automatically set the MY (Source Address)

parameter from the factory-set serial number of the module. The address is formed with bits 29, 28 and 13-0 of the serial number (in that order). The resulting value is displayed as a result of this command.

AP (API Enable) Command

<Serial Interfacing> The AP command is used to enable the module to operate using the framebased API operation.

AT Command: ATAP

Parameter Range: 0 - 2

Parameter	Configuration
0	API Disabled (Transparent Operation)
1	API enabled (w/out escaped characters)
2	API enabled (with escaped characters)

Default Parameter Value:0

Number of Bytes Returned:1

Minimum Firmware Version Required: 2.x20

AT (Guard Time After)**Command**

<Command Mode Options> AT Command is used to set/read the time-of-silence that follows the command sequence character (CC Command) of the AT Command Mode Sequence (BT + CC + AT). By default, 1 second must elapse before and after the command sequence character.

AT Command: ATAT

Binary Command: 0x05 (5 decimal)

Parameter Range: 2 - (ATST-3), up to 0x7FFC [x 100 milliseconds]

Default Parameter Value: 0x0A (10 decimal)

Number of bytes returned: 2

Related Commands: BT (Guard Time Before), CC (Command Sequence Character)

The times-of-silence surrounding the command sequence character are used to prevent inadvertent entrance into AT Command Mode. Refer to the 'AT Command Mode' section for more information regarding the AT Command Mode Sequence.

BD (Interface Data Rate)**Command**

<Serial Interfacing> The BD command is used to set and read the serial interface data rate (baud rate) used between the RF module and host. This parameter determines the rate at which serial data is sent to the module from the host. Modified interface data rates do not take effect until the CN (Exit AT Command Mode) command is issued and the system returns the 'OK' response.

When parameters 0-8 are sent to the module, the respective interface data rates are used (as shown in the table on the right).

The RF data rate is not affected by the BD parameter. If the interface data rate is set higher than the RF data rate, a flow control configuration may need to be implemented.

AT Command: ATBD

Binary Command: 0x15 (21 decimal)

Parameter Ranges: 0 - 8 (standard rates)_ 0x39 - 0x1C9C38 (non-standard rates)

Parameter	Configuration (bps)
0	1200
1	2400
2	4800
3	9600
4	19200
5	38400
6	57600
7	115200
8	230400

Default Parameter Value: 3

Non-standard baud rates supported as of firmware v2.x20

Number of bytes returned: 4

The range between standard and non-standard baud rates (0x09 - 0x38) is invalid.

Non-standard Interface Data Rates:

Any value above 0x38 will be interpreted as an actual baud rate. When a value above 0x38 is sent, the closest interface data rate represented by the number is stored in the BD register. For example, a rate of 19200 bps can be set by sending the following command line "ATBD4B00".

When the BD command is sent with a non-standard interface data rate, the UART will adjust to accommodate the requested interface rate. In most cases, the clock resolution will cause the stored BD parameter to vary from the parameter that was sent (refer to the table below). Reading the BD command (send "ATBD" command without an associated parameter value) will return the value actually stored in the module's BD register.

Parameters Sent Versus Parameters Stored

BD Parameter Sent (HEX)	Interface Data Rate (bps)	BD Parameter Stored (HEX)
0	1200	0
4	19,200	4
7	115,200	7
12C	300	12B
1C200	115,200	1B207

BR (RF Data Rate) Command

<RF Interfacing> The BR command is used to set and read the RF data rate (rate that RF data is transmitted over-the-air) of the module.

AT Command: ATBR

Binary Command: 0x39 (57 decimal)

Parameter Range: 0 - 1

Parameter	Baud (bps) Configuration
0	9600
1	115200

Default Parameter Value: 1

Number of bytes returned: 1

BT (Guard Time Before) Command

<AT Command Mode Options>

The CC command is used to set/read the ASCII character used between guard times of the AT Command Mode Sequence (BT + CC + AT).

This sequence enters the module into AT Command

Mode so that data entering the module (from the host) is recognized as commands instead of payload.

AT Command: ATCC

Binary Command: 0x13 (19 decimal)

Parameter Range: 0x20 - 0x7F

Default Parameter Value: 0x2B (ASCII "+")

Number of bytes returned: 1

Related Commands: AT (Guard Time After), BT (Guard Time Before)

Refer to the 'AT Command Mode' section for more information regarding the AT Command Mode Sequence.

CC (Command Sequence Character) Command
<AT Command Mode Options>
The CC command is used to set/read the ASCII character used between guard times of the AT Command Mode Sequence (BT + CC + AT). This sequence enters the module into AT Command Mode so that data entering the module (from the host) is recognized as commands instead of payload.

AT Command: ATCC

Binary Command: 0x13 (19 decimal)

Parameter Range: 0x20 - 0x7F

Default Parameter Value: 0x2B (ASCII "+")

Number of bytes returned: 1

Related Commands: AT (Guard Time After), BT (Guard Time Before)

Refer to the 'AT Command Mode' section for more information regarding the AT Command Mode Sequence.

CD (GPO2 Configuration) Command
<Serial Interfacing> CD
Command is used to select/read the behavior of the GPO2 line (pin 3).

AT Command: ATCD

Binary Command: 0x28 (40 decimal)

Parameter Range: 0 - 8 (standard rates)

Parameter	Configuration
0	RX LED
1	Default High
2	Default Low
3	(reserved)
4	RX LED (valid address only)

Default Parameter Value: 2

Number of bytes returned: 1

CF (Number Base) Command
 <Command Mode Options> CF command is used to set/read the command formatting setting. The following commands are always entered and read in hex, no matter the CF setting:

VR (Firmware Version)
 HV (Hardware Version)
 KY (AES Encryption Key)

AT Command: ATCF

Parameter Range: 0 – 2

Parameter	Configuration
0	Commands utilize default number base; decimal commands may output units
1	All commands forced to unsigned, unit-less hex
2	Commands utilize their default number base; no units are output

Default Parameter Value: 1

Number of bytes returned: 1

CN (Exit AT Command Mode) Command

<Command Mode Options> The CN command is used to explicitly exit the module from AT Command Mode.

AT Command: ATCN

Binary Command: 0x09 (9 decimal)

CS (GP01 Configuration) Command

<Serial Interfacing> CS Command is used to select the behavior of the GP01 pin (pin 9). This output can provide RS-232 flow control, control the TX enable signal (for RS-485 or RS-422 operations).

By default, GP01 provides RS-232 **CTS** (Clear-to- Send) flow control.

AT Command: ATCS

Binary Command: 0x1F (31 decimal)

Parameter Range: 0 - 4

Parameter	Configuration
0	RS-232 CTS flow control
1	RS-485 TX enable low
2	High
3	RS-485 TX enable high
4	Low

Default Parameter Value: 0

Number of bytes returned: 1

Related Commands: RT (GPI1 Configuration), TO (GP01 Timeout)

CT (Command Mode Timeout) Command	AT Command: ATCT
<Command Mode Options> The CT command is used to set and read the amount of inactive time that elapses before the module automatically exits from AT Command Mode and returns to Idle Mode.	Binary Command: 0x06 (6 decimal)
	Parameter Range: 2 - 0xFFFF [x 100 milliseconds]
	Default Parameter Value: 0xC8 (200d)
	Number of bytes returned: 2
Use the CN (Exit AT Command Mode) command to exit AT Command Mode manually.	Related Command: CN (Exit AT Command Mode)

DB (Received Signal Strength) Command	AT Command: ATDB
<Diagnostics> DB Command is used to read the receive signal strength (in decibels relative to milliwatts) of the last received packet. This parameter is useful in determining range characteristics of the Zlinx Radio Modems under various conditions.	Binary Command: 0x36 (54 decimal)
	Parameter Range (read-only): 0x6E - 0x28 (-110 to -40 Decimal)
	Number of bytes returned: 2

In default mode, this command shows the power level in signed decimal format with the units (dBm). If CF = 1, the magnitude of the value is presented in unsigned hex. If CF = 2, the value is presented in decimal, but without the units.

Sample Output: -88 dBm(when ATCF = 0)
58 (when ATCF = 1)
-88 (when ATCF = 2)

NOTE: If the DB register is read before the module has received an RF packet, the module will return a value of 0x8000 (which means an RF packet has not yet been received).

DT (Destination Address) Command	AT Command: ATDT
<Networking & Security> DT Command is used to set/read the networking address of an RF module. The modules utilize three filtration layers: Vendor ID Number (ATID), Channel (ATHP), and Destination Address (ATDT). The DT command assigns an address to a module that enables it to communicate only with other modules having the same address. All modules that share the same DT parameter can communicate with each other.	Binary Command: 0x00
	Parameter Range: 0 - 0xFFFF
	Default Parameter Value: 0
	Number of bytes returned: 2
	Related Commands: HP (Hopping Channel), ID (Modem VID), MK (Address Mask), MY (Source Address)

Zlinx Radio Modems in the same network with a different destination address (than that of the transmitter) will listen to all transmissions to stay synchronized, but will not send any of the data out their serial ports.

E0 (Echo Off) Command
 <Command Mode Options> E0
 Command turns off character
 echo in AT Command Mode.

AT Command: ATE0
 Binary Command: 0x0A (10 decimal)

By default, echo is off.

E1 (Echo On) Command
 <Command Mode Options> E1
 Command enables character
 echo in AT Command Mode.
 Each typed character will be echoed back to the terminal when ATE1 is active.
 E0 (Echo Off) is the default.

AT Command: ATE1
 Binary Command: 0x0B (11 decimal)

ER (Receive Error Count) Command

<Diagnostics> The ER command is used to set/read the number of receive-errors. The error count records the number of packets partially received then aborted on a reception error. This value returns to 0 after a reset and is not nonvolatile (Value does not persist in the module's memory after a power-up sequence). Once the Receive Error Count reaches its maximum value (up to 0xFFFF), it remains at its maximum count value until the maximum count value is explicitly changed or the module is reset.

AT Command: ATER
 Binary Command: 0x0F (15 decimal)
 Parameter Range: 0 - 0xFFFF
 Default Parameter Value: 0
 Number of bytes returned: 2
 Related Commands: GD (Receive Good Count)

The ER parameter is not reset by pin, serial port or cyclic sleep modes.

AT Command: ATFH
 Binary Command: 0x0D (13 decimal)

FH (Force Wake-up Initializer) Command

<Sleep (Low Power)> The FH command is used to force a Wake-up Initializer to be sent on the next transmission. Use only with cyclic sleep modes active on remote modules.
 ATFH will not send a long header if ATHT = 0xFFFF. WR (Write) Command does not need to be issued with FH Command.

FL (Software Flow Control) Command

<Serial Interfacing> The FL command is used to configure software flow control. Hardware flow control is implemented with the module as the GP01 pin (CTS pin of the OEM RF module), which regulates when serial data can be transferred to the module.

AT Command: ATFL
 Binary Command: 0x07 (7 decimal)
 Parameter Range: 0 - 1

Parameter	Configuration
0	Disable software flow control
1	Enable software flow control

FL Command can be used to allow software flow control to also be enabled. The XON character used is 0x11 (17 decimal). The XOFF character used is 0x13 (19 decimal)

Default Parameter Value: 0
 Number of bytes returned: 1

FS (Forced Synchronisation Time) Command

<RF Interfacing> The FS command only applies to streaming data. Normally, only the first packet of a continuous stream contains the full RF initializer. Zlinx Radio Modems then remain synchronized for

subsequent packets of the stream. This parameter can be used to periodically force an RF initializer during such streaming. Any break in UART character reception long enough to drain the DI Buffer (UART receive buffer) and cause a pause in RF data transmission will also cause an RF initializer to be inserted on the next transmission.

AT Command: ATFS

Binary Command: 0x3E (62 decimal)

Parameter Range: 0 - 0xFFFF [x 10 milliseconds]

Default Parameter Value: 0

Number of bytes returned: 2

FT (Flow Control Threshold) Command

<Serial Interfacing> The FT command is used to set/read the flow control threshold. When FT

bytes have accumulated in the DI buffer (UART Receive), CTS is de-asserted or the XOFF software flow control character is transmitted.

AT Command: ATFT

Binary Command: 0x24 (36 decimal)

Parameter Range: 0 - (DI buffer size minus 0x11) [Bytes]

Default Parameter Value: DI Buffer size minus 0x11 (17 decimal)

Number of bytes returned: 2

GD (Receive Good Count) Command

<Diagnostics> The GD command is used to set/read the count of good received RF packets. Its parameter value is reset to 0 after every reset and is not non-volatile (The parameter value does not persist in the RF module's memory after a power-up sequence). Once the "Receive Good Count" reaches its maximum value (up to 0xFFFF), it remains at its maximum count value until the maximum count value is manually changed or the module is reset.

AT Command: ATGD

Binary Command: 0x10 (16 decimal)

Parameter Range: 0 - 0xFFFF

Default Parameter Value: 0

Number of bytes returned: 2

Related Commands: ER (Receive Error Count)

The GD parameter is not reset by pin, serial port or cyclic sleep modes.

HP (Hopping Channel)**Command**

<Networking & Security> The HP command is used to set/read the RF module's hopping channel number. A channel is one of three layers of filtration available to the module.

In order for modules to communicate with each other, the modules must have the same channel number since each channel uses a different hopping sequence. Different channels can be used to prevent modules in one network from listening to transmissions of another.

AT Command: ATHP

Binary Command: 0x11 (17 decimal)

Parameter Range: 0 - 9

Default Parameter Value: 0

Number of bytes returned: 1

Related Commands: ID (Modem VID), DT (Destination Address), MK (Address Mask)**HT (Time before Wake-up Initializer) Command**

<Sleep (Low Power)> The HT command is used to set/read the time of inactivity (no serial or RF

data is sent or received) before a wake-up initializer is sent by a TX (transmitting) RF module. The HT parameter should be set shorter than inactivity timeout [ST Command] time of any RX (receiving) modules operating in Cyclic Sleep (SM=4-8). The

wake-up initializer sent by the TX module instructs all RX modules to remain awake to receive RF data.

From the RX module perspective: After HT time elapses and the inactivity timeout [ST Command] is met, the RX module goes into cyclic sleep. In cyclic sleep, the RX module wakes once per sleep interval [SM Command] to check for a wake-up initializer. When a wake-up initializer is detected, the module stays awake to receive data. The wake-up initializer must be longer than the cyclic sleep interval to ensure that sleeping modules detect incoming data.

When HT time elapses, the TX module knows it needs to send a wake-up Initializer for all RX modules to remain awake and receive the next transmission.

AT Command: ATHT

Binary Command: 0x03 (3 decimal)

Parameter Range: 0 - 0xFFFF [x 100 milliseconds]

Default Parameter Value: 0xFFFF (wake-up initializer will not be sent)

Number of bytes returned: 2

Related Commands: LH (Wake-up Initializer Timer), SM (Sleep Mode), ST (Time before Sleep)**HV (Hardware Version)****Command**

<Diagnostics> The HV

command is used to read the hardware version of the RF module.

AT Command: ATHV

Parameter Range: 0 - 0xFFFF [Read-only]

ID (Modem VID) Command

<Networking & Security> The ID command is used to set/read the VID (Vendor Identification Number) of the RF module. Zlinx Radio Modems must have matching VIDs in order to communicate.

AT Command: ATID

Binary Command: 0x27 (39 decimal)

Parameter Range: 0x11 - 0x7FFF (user-settable)
0 - 0x10 & 0x8000 - 0xFFFF (factory-set)

Default Parameter Value: 0x3332 (13106d)

Number of bytes returned: 2

KY (AES Encryption Key) Command

<Networking & Security> The KY command is used to set the 256-bit AES (Advanced Encryption Standard) key for encrypting/decrypting data. Once set, the key cannot be read out of the module by any means. The entire payload of the packet is encrypted using the key and the CRC is computed across the ciphertext. When encryption is enabled, each packet carries an additional 16 bytes to convey the random CBC Initialization Vector (IV) to the receiver(s). The KY value may be "0" or any 256-bit value (= 64 hex digits = 32 bytes). Any other value, including entering ATKY by itself with no parameters, causes an error.

AT Command: ATKY

Binary Command: 0x3C (60 decimal)

Parameter Range: 0 - (any other 64-digit hex valid key)

Default Parameter Value: 0 (disabled)

Number of bytes returned: 2

Number Base: Always Hexadecimal

A module with the wrong key (or no key) will receive encrypted data, but the data driven out the serial port will be meaningless. Likewise, a module with a key will receive unencrypted data sent from a module without a key, but the output will be meaningless. Because CBC mode is utilized, repetitive data appears differently in different transmissions due to the randomly-generated IV.

LH (Wake-up Initializer Timer) Command

<Sleep (Low Power)> The LH Command is used to set/read the duration of time during which the wake-up initializer is sent. When receiving modules are in Cyclic Sleep Mode, they power-down after a period of inactivity (as specified by the ST parameter) and will periodically wake and listen for transmitted data. In order for the receiving modules to remain awake, they must detect ~35ms of the wake-up initializer.

AT Command: ATLH

Binary Command: 0x0C (12 decimal)

Parameter Range: 0 - 0xFF [x 100 milliseconds]

Default Parameter Value: 1

Number of bytes returned: 1

Related Commands: HT (Time before Wake-up Initializer), SM (Sleep Mode), ST (Time before Sleep)

LH Command must be used whenever a receiving module is operating in Cyclic Sleep Mode. The Wake-up Initializer Time must be longer than the cyclic sleep time that [as determined by SM (Sleep Mode) parameter]. If the wake-up initializer time were less than the Cyclic Sleep interval, the connection would be at risk of missing the wake-up initializer transmission.

Refer to figures located under the SM command description to view diagrams of correct and incorrect configurations. The images emphasize that the LH value must be greater than the SM value.

MD (RF Mode) Command

<Networking & Security> The MD command is used to select/read the settings that enable the Polling and Repeater Modes on the module.

Polling Mode - A 'Polling Base' is responsible for polling remotes. A 'Polling Remote' requires a poll in order to transmit.

Repeater Mode - A 'Repeater' re-sends RF data unless the transmission is addressed to it or if the transmission has already been detected. A 'Repeater End Node' handles repeated messages, but will not repeat the message over-the-air.

Refer to the Polling and Repeater Mode sections of the 'RF Communication Modes' chapter for more information.

AT Command: ATMD

Binary Command: 0x31 (49 decimal)

Parameter Range: 0 - 6

Parameter	Configuration
0	Transparent Operation (Repeater Base)
1	[reserved - not used]
2	[reserved - not used]
3	Polling Base
4	Polling Remote
5	Repeater
6	Repeater End Node

Default Parameter Value: 0

Number of bytes returned: 1

Minimum Firmware Version Required: 2.x20

MK (Address Mask) Command

<Networking & Security> The MK command is used to set/read the Address Mask of a module.

All RF data packets contain the Destination Address of the TX (transmitting) module. When a packet is received, the TX module Destination Address is logically "ANDed" (bitwise) with the Address Mask of the RX (receiving) module. The resulting value must match the Destination Address or Address Mask of the RX module for the packet to be received and sent out the RX module's DO (Data Out) pin. If the "ANDed" value does not match the Destination Address or Address Mask of the RX module, the packet is discarded.

Sniffer Mode (when MK = 0): ACK requests are ignored and every RX (receive) frame is sent to the UART, without regard for repeated frames. All "0" values are treated as irrelevant values and ignored.

AT Command: ATMK

Binary Command: 0x12 (18 decimal)

Parameter Range: 0 - 0xFFFF

Default Parameter Value: 0xFFFF (65535d)

Number of bytes returned: 2

Related Commands: DT (Destination Address), HP (Hopping Channel), ID (Modem VID), MY (Source Address)

MT (Multi-transmit) Command

<Networking & Security> The MT command is used to enabled multiple transmissions of RF data packets. When Multi-transmit Mode is enabled (MT > 0), packets do not request an ACK (acknowledgement) from the receiving RF module(s). MT takes precedence over RR, so if both MT and RR are non-zero, then MT+1 packets will be sent (with no ACK requests).

AT Command: ATMT

Binary Command: 0x3D (61 decimal)

Parameter Range: 0 - 0xFF

Default Parameter Value: 0 (no forced retransmissions)

Number of bytes returned: 1

Related Commands: Networking (DT, MK, MY, RN, TT), Serial Interfacing (BR, PK, RB, RO), RF Interfacing (FS)

When a receiving module receives a packet with remaining forced retransmissions, it calculates the length of the packet and inhibits transmission for the amount of time required for all retransmissions. Thereafter, a random number of delay slots are inserted between 0 and RN before transmission is allowed from the receiving module(s). This prevents all listening modules from transmitting at once upon conclusion of a multiple transmission event (when RN > 0).

NOTE: The actual number of forced transmissions is the parameter value plus one. For example, if MT = 1, two transmissions of each packet will be sent.

MY (Source Address)**Command**

<Networking & Security> The MY command is used to set/read the Source Address of the RF module.

AT Command: ATMY

Binary Command: 0x2A (42 decimal)

Parameter Range: 0 - 0xFFFF

Default Parameter Value: 0xFFFF (Disabled - DT (Destination Address) parameter serves as both source and destination address.)

Number of bytes returned: 2

Related Commands: DT (Destination Address), HP (Hopping Channel), ID (Modem VID), MK (Address Mask)

NB (Parity) Command

<Serial Interfacing> The NB command is used to select/read the parity settings of the RF module for UART communications.

AT ATNB

Command:

Binary Command: 0x23 (35 decimal)

Parameter Range: 0 - 4

Parameter	Configuration
0	8-bit (no parity or 7-bit (any parity))
1	8-bit even
2	8-bit odd
3	8-bit mark
4	8-bit space

Default Parameter Value: 0

Number of bytes returned: 1

PB (Polling Begin Address) Command

<Networking & Security> PB command is used to set/read the module's Polling Begin Address – the first address polled Polling Mode is enabled.

Polling Operations: The 'Polling Base' (MD = 3) cycles through a sequential range of addresses, polling each 'Polling Remote' (MD = 4). The base then waits for a response & proceeds to the next 'Polling Remote'. Each 'Polling Remote' responds by sending the data from the Data In buffer following the RB & RO parameters. When there is no eligible data to send, the 'Polling Remote' will not respond. The 'Polling Base' will move to the next address in the polling sequence after a short delay.

AT Command: ATPB

Binary Command: 0x45 (69 decimal)

Parameter Range: 0 - 0xFFFF

Default Parameter Value: 0

Number of bytes returned: 2

Minimum Firmware Version Required: 2.x20

Related Commands: MD (RF Mode), PE (Polling End Address), PD (Minimum Polling Delay)

PD (Minimum Polling Delay) Command
<Networking & Security> The PD command is used to set/read Polling Delay (Base, MD=3) or Polling Timeout (Remote, MD=4).

Polling Delay (Base) is the time between polling cycles. The Polling Base will start the polling cycle after sending the first poll. After the polling cycle has completed, the timer is restarted.

Polling Timeout (Remote) is the amount of time the remote unit will hold data from the serial port before discarding it. Data entered within the PD time of the poll is transmitted and not discarded.

AT Command: ATPD

Binary Command: 0x47 (71 decimal)

Parameter Range: 0 - 0xFFFF_ (Base: [x 1ms], Remote: [x 10ms])

Default Parameter Value: 0

Number of bytes returned: 2

Minimum Firmware Version Required: 2.x20

Related Commands: MD (RF Mode), PB (Polling Begin Address), PE (Polling End Address)

PE (Polling End Address) Command
<Networking & Security> PE command is used to set/read the module's Polling End Address – the last address polled when Polling Mode is enabled.

Polling Operations: The 'Polling Base' (MD = 3) cycles through a sequential range of addresses, polling each 'Polling Remote' (MD = 4). The base then waits for a response & proceeds to the next 'Polling Remote'. Each 'Polling Remote' responds by sending data from the DI buffer following the RB & RO parameters. When there is no eligible data to send, the 'Polling Remote' will not respond. The 'Polling Base' will move to the next address in the polling sequence after a short delay.

AT Command: ATPE

Binary Command: 0x46 (70 decimal)

Parameter Range: 0 - 0xFFFF

Default Parameter Value: 0

Number of bytes returned: 2

Minimum Firmware Version Required: 2.x20

Related Commands: MD (RF Mode), PB (Polling Begin Address), PD (Minimum Polling Delay)

PK (Maximum RF Packet Size) Command
<RF Interfacing> The PK command is used to set/read the maximum size of RF packets transmitted from an RF module. The maximum packet size can be used along with the RB and RO parameters to implicitly set the channel dwell time.

If PK is set above 256 and BR is subsequently changed to 0, PK will automatically be lowered to 256 and a warning will be raised (refer to the BR (RF Data Rate) and WN (Warning Data) commands for details).

AT Command: ATPK

Binary Command: 0x29 (41 decimal)

Parameter Range: 1 - 0x800 [Bytes]

Default Parameter Value: 0x100* or 0x800* (256 or 2048 decimal)

Number of bytes returned: 2

Related Commands: BR (RF Data Rate) RB (Packetization Threshold), RO (Packetization Timeout), WN (Warning Data)

Changes to the PK parameter may have a secondary effect on the RB (Packetization Threshold) parameter. RB must always be less than or equal to PK. If PK is changed to a value that is less than the current value of RB, the RB value is automatically lowered to be equal to PK.

* When BR = 0 (9600 baud), the maximum PK value is 0x100 (256d). When BR = 1 (115,200 baud), the maximum PK value is 0x800 (2048d).

PL (TX Power Level)

Command

<RF Interfacing> The PL command is used to set/read the power level at which the RF module transmits data

AT Command: ATPL	
Binary Command: 0x3A (58 decimal)	
Parameter Range:	0 - 4
Parameter	Configuration
0	1 mW
1	10 mW
2	100 mW
3	500 mW
4	1000 mW (1 Watt)
Default Parameter Value: 4	
Number of bytes returned: 1	

PW (Pin Wake-up) Command

<Sleep (Low Power)> Under normal operation, an RF module in Cyclic Sleep Mode cycles from an active state to a low-power state at regular intervals until data is ready to be received. If the PW parameter is set to 1, the SLEEP pin (pin 8) can be used to awaken the module from Cyclic Sleep. When the SLEEP Pin is de-asserted (low), the module will be fully operational and will not go into Cyclic Sleep.

AT Command:	ATPW
Binary Command: 0x1D (29 decimal)	
Parameter Range:	0 - 1
Parameter	Configuration
0	Disabled
1	Enabled
Default Parameter Value: 0	
Number of bytes returned: 1	
Related Commands: SM (Sleep Mode), ST (Time before Sleep)	

Once the SLEEP pin is asserted, the module will remain active for the period of time specified by the ST (Time before Sleep) parameter and will return to Cyclic Sleep Mode (if no data is ready to be transmitted). PW Command is only valid if Cyclic Sleep has been enabled.

RB (Packetization Threshold) Command
 <Serial Interfacing> The RB command is used to set/read the character threshold value. RF transmission begins after data is received in the DI Buffer and either of the following criteria is met:

- RB characters received by the UART
- RO character times of silence detected on the UART receive lines (after receiving at least 1 Byte of data)

If PK (Max. RF Packet Size) is lowered below the value of RB, RB is automatically lowered to match the PK value. If (RO = 0), RB bytes must be received before beginning transmission.

AT Command: ATRB

Binary Command: 0x20 (32 decimal)

Parameter Range: 0 - PK parameter value (up to 0x800 Bytes)

Default Parameter Value: 0x800 Bytes

Number of bytes returned: 2

Related Commands: BR (RF Data Rate), PK (RF Packet Size), RO (Packetization Timeout)

Note: RB and RO criteria only apply to the first packet of a multi-packet transmission. If data remains in the DI Buffer after the first packet, transmissions will continue in a streaming manner until there is no data left in the DI Buffer (UART receive buffer).

RC (Ambient Power - Single Channel) Command
 <Diagnostics> The RC command is used to examine and report the power level on a given channel.

Sample output: -78 dBm [when CF = 0]
 4e [when CF = 1]
 -78 [when CF = 2]

AT Command: ATRC

Parameter Range (read-only): 0 - 0x31 [dBm]

Number of bytes returned: 1

Related Commands: RM (Ambient Power - All Channels)

RE (Restore Defaults) Command
 <Diagnostics> The RE command is used to restore all configurable parameters to their factory default settings.

AT Command: ATRE

Binary Command: 0x0E (14 decimal)

The RE Command does not cause default values to be stored to non-volatile (persistent) memory. For the restored default settings to persist in the module's non-volatile memory and be saved in the event of RF module reset or power-down, the WR (Write) command must be issued prior to power-down or reset.

RM (Ambient Power - All Channels) Command
 <Diagnostics> The RM command is used to examine and report power levels on all channels. If no parameter is given, the channels are scanned one time. If a parameter is given, the

AT Command: ATRM

Parameter Range: no parameter - 0x7D0

Number of bytes returned: 2

Related Commands: RC (Ambient Power - Single channel)

channels are repeatedly scanned for that number of seconds. The maximum power level seen for each channel is reported (i.e. peak hold).

A graphical spectrum analyzer can be implemented by repeatedly sending the RM command (with no arguments) and reading the resultant 50 power levels (this is easiest to do when CF = 1 or 2).

Sample output [when CF = 0]: Ch 0: -100 dBm
Ch 1: -103 dBm
...

Sample output [when CF = 1]: 64
67
...

Sample output [when CF = 2]: 100
-103
...

RN (Delay Slots) Command

<Networking & Security> The RN command is used to set/read the time delay that the transmitting RF module inserts before attempting to resend a packet. If the transmitting module fails to receive an acknowledgement after sending a packet, it inserts a random number of delay slots (ranging from 0 to (RN minus 1)) before attempting to resend the packet. Each delay slot is 5 msec (when BR=1) and 54 msec (when BR=0).

AT Command: ATRN

Binary Command: 0x19 (25 decimal)

Parameter Range: 0 - 0xFF [38 ms slots]

Default Parameter Value: 0 (no delay slots inserted)

Number of bytes returned: 1

Related Commands: RR (Retries), TT (Streaming Limit)

If two modules attempt to transmit at the same time, the random time delay after packet failure allows only one module to transmit the packet successfully; while the other module waits until the channel available for RF transmission.

RN Command is only applicable if retries have been enabled [RR (Retries) Command] or if forced delays will be inserted into a transmission [TT (Streaming Limit) Command].

RO (Packetization Timeout) Command

<Serial Interfacing> The RO command is used to set/read the Packetization Timeout setting. RF transmission begins when data is in the DI buffer and either of the following criteria are met:

- RO character times of silence on the UART receive lines (after receiving at least 1 byte)

AT Command: ATRO

Binary Command: 0x21 (33 decimal)

Parameter Range: 0 - 0xFFFF [x UART character times]

Default Parameter Value: 3

Number of bytes returned: 2

Related Commands: RB (Packetization Threshold)

- RB characters have been received by the UART

RB and RO criteria only apply to the first packet of a multi-packet transmission. If data remains in the DI Buffer (UART receive) after the first packet, transmissions will continue in a streaming manner until there is no data left in the DI Buffer.

When RO is the transmission-beginning criteria: The actual time between the reception of the last character from the UART and the beginning of RF transmission will be at least 800 µsec longer than the actual RO time to allow for transmission setup. Additionally, it is subject to 100-200 µsec of additional uncertainty, which could be significant for small values of RO at high UART bit rates.

The correct UART character time (10, 11, or 12 bits) is calculated based on the following criteria:

- 1 start bit
- 8 data bits
- 0 or 1 parity bit [as determined by the NB (Parity) Command]
- 1 or 2 stop bits [as determined by SB (Stop Bits) Command]

RP (RSSI PWM Timer) Command

<Diagnostics> RP Command is used to enable a PWM ("Pulse Width Modulation") output on the Config/RSSI pin (pin 11 of the OEM RF Module). The pin is calibrated to show the difference between received signal strength and the sensitivity level of the RF module. PWM pulses vary from zero to 95 percent. Zero percent means the received RF signal is at or below the published sensitivity level of the module.

AT Command: ATRP

Binary Command: 0x22 (34 decimal)

Parameter Range: 0 - 0xFF [x 100 milliseconds]

Default Parameter Value: 0x20 (32d)

Number of bytes returned: 1

The following table shows dB levels above sensitivity and PWM values (The total time period of the PWM output is 8.32 ms. PWM output consists of 40 steps and therefore the minimum step size is 0.208 ms.):

PWM Values

dBm above sensitivity	PWM percentage (high period / total period)
10	20%
20	35%
30	50%

A non-zero value defines the time that PWM output is active with the RSSI value of the last received RF packet. After the set time when no RF packets are received, PWM output is set low (0 percent PWM) until another RF packet is received. PWM output is also set low at power-up. A parameter value of 0xFF permanently enables PWM output and always reflects the value of the last received RF packet.

The Config/RSSI pin is shared between PWM output and Config input. When the module is powered, the Config pin is an input. During the power-up sequence, if RP

parameter is a non-zero value, the Config pin is configured as an output and set low until the first RF packet is received. With a non-zero RP parameter, the Config pin is an input for RP ms after power up.

RR (Retries) Command

<Networking & Security> The RR command is used to set/read the maximum number of retries sent for a given RF packet. When RR Command is enabled (RR>0), RF packet retries and ACKs (acknowledgements) are enabled.

AT Command: ATRR

Binary Command: 0x18 (24 decimal)

Parameter Range: 0 - 0xFF

Default Parameter Value: 0x0A (10 decimal)

Number of bytes returned: 1

Exceptions: If the MT command is enabled (MT>0) or if a broadcast Destination Address is used (DT = 0xFFFF); RF packet retries and ACKs are disabled. After transmitting a packet, the transmitting RF module waits to receive an acknowledgement from a receiving module. If the acknowledgement is not received in the period of time specified by RN (Delay Slots) Command, the original packet is transmitted again. The RF packet is transmitted repeatedly until an acknowledgement is received or until the packet is sent RR times.

RT (GPI1 Configuration) Command

<Serial Interfacing> The RT command is used to set/read the behavior of the GPI1 pin (pin 10) of the OEM RF Module. The pin can be configured to enable binary programming or RTS flow control.

AT ATRT

Command:

Binary Command: 0x16 (22 decimal)

Parameter Range: 0 - 2

Parameter	Configuration
0	Disabled
1	Enable Binary Programming
2	Enable RTS Flow Control

Default Parameter Value: 0

Number of bytes returned: 1

SB (Stop Bits) Command

<Serial Interfacing> The SB Command is used to set/read the number of stop bits in the data packet.

AT ATSB

Command:

Binary Command: 0x37 (55 decimal)

Parameter Range: 0 - 1

Parameter	Configuration
0	1 stop bit
1	2 stop bits

Default Parameter Value: 0

Number of bytes returned: 1

SH (Serial Number High)**Command**

<Diagnostics> SH Command is used to set/read the serial number high word of the RF module.

AT Command: ATSH

Binary Command: 0x25 (37 decimal)

Parameter Range (read-only): 0 - 0xFFFF

Default Parameter Value: varies

Number of bytes returned: 2

Related Commands: SL (Serial Number Low)

SL (Serial Number Low)**Command**

<Diagnostics> SL Command is used to set/read the serial number low word of the RF module.

AT Command: ATSL

Binary Command: 0x26 (38 decimal)

Parameter Range (read-only): 0 - 0xFFFF

Default Parameter Value: varies

Number of bytes returned: 2

Related Commands: SH (Serial Number High)

SM (Sleep Mode) Command

<Sleep Mode (Low Power)> The SM Command is used to set/read the RF module's Sleep Mode settings that configure the module to run in states that require minimal power consumption.

AT ATSM

Command:

Binary Command: 0x01

Parameter Range: 0 - 8 (3 is reserved)

Parameter	Configuration
0	Disabled
1	Pin Sleep
2	Serial Port Sleep
3	[reserved]
4	Cyclic 1.0 second sleep (RF module wakes every 1.0 seconds)
5	Cyclic 2.0 second sleep
6	Cyclic 4.0 second sleep
7	Cyclic 8.0 second sleep
8	Cyclic 16.0 second sleep

Default Parameter Value: 0

Number of bytes returned: 1

Related Commands: Pin Sleep - PC (Power-up Mode), PW (Pin Wake-up) Serial Port Sleep - ST (Time before Sleep) Cyclic Sleep - ST (Time before Sleep), LH (Wake-up Initializer Timer), HT (Time Before Wake-up Initializer), PW (Pin Wake-up)

ST (Time before Sleep)**Command**

<Sleep Mode (Low Power)> The ST Command is used to set/read the period of time (in milliseconds) in which the RF module remains inactive before entering Sleep Mode.

For example, if the ST Parameter is set to 0x64 (100 decimal), the module will enter into Sleep mode after 10 seconds of inactivity (no transmitting or receiving).

This command can only be used if Cyclic Sleep or Serial Port Sleep Mode settings have been selected using SM (Sleep Mode) Command.

 AT Command: ATST

 Binary Command: 0x02 (2 decimal)

 Parameter Range: (ATAT+3) - 0x7FFF [x 100 milliseconds]

 Default Parameter Value: 0x64 (100 decimal)

 Number of bytes returned: 2

 Related Commands: SM (Sleep Mode), LH (Wake-up Initializer Timer), HT (Time before Wake-up Initializer)

TP (Board Temperature)**Command**

<Diagnostics> TP Command is used to read the current temperature of the board.

Sample Output:

26 C [when
ATCF = 0]
1A [when ATCF = 1]
26 [when ATCF = 2].

 AT Command: ATTP

 Binary Command: 0x38 (56 decimal)

 Parameter Range (read-only): 0- 0x7F

 Number of bytes returned: 1

 Related Command: WN (Warning Data)

TR (Transmit Error Count)**Command**

<Diagnostics> The TR command is used to report the number of retransmit failures. This number is incremented each time a packet is not acknowledged within the number of retransmits specified by the RR (Retries) parameter. The number of packets therefore are counted that were not successfully received and subsequently discarded.

The TR parameter is not non-volatile and is reset to zero when the RF module is reset.

 AT Command: ATTR

 Binary Command: 0x1B (27 decimal)

 Parameter Range: 0 - 0xFFFF

 Default Parameter Value: 0

 Number of bytes returned: 2

 Related Commands: RR (Retries)

TT (Streaming Limit)**Command**

<Networking & Security> The TT command is used to set/read the limit on the number of bytes that can be sent out before a random delay is issued.

If an RF module is sending a continuous stream of RF data, a delay is inserted which stops its transmission

 AT Command: ATTT

 Binary Command: 0x1A (26 decimal)

 Parameter Range: 0 - 0xFFFF

 Default Parameter Value: 0 (disabled)

 Number of bytes returned: 2

 Related Commands: RN (Delay Slots)

and allows other modules time to transmit (once it sends TT bytes of data). Inserted random delay lasts between 1 & 'RN + 1' delay slots, where each delay slot lasts 38 ms.

The TT command can be used to simulate full-duplex behavior.

TX (Transmit Only) Command

<RF Interfacing> The TX command is used to set/read the transmit/receive behaviors of the RF module. Setting a module to TX-only (TX = 1) may reduce latency because the transmitting module will never be confined to receiving data from other modules.

AT Command:	ATTX
Binary Command:	0x3F (63 decimal)
Parameter Range:	0 - 1
Parameter	Configuration
0	TX & RX
1	TX-only
Default Parameter Value:	0
Number of bytes returned:	1

VL (Firmware Version - Verbose)

<Diagnostics> The VL command is used to read the verbose firmware version of the RF module.

AT Command:	ATVL
Parameter Range:	returns string
Default Parameter Value:	0
Number of bytes returned:	2

VR (Firmware Version - Short) Command

<Diagnostics> The VR command is used to read the firmware version of the RF module.

AT Command:	ATVR
Binary Command:	0x14 (20 decimal)
Parameter Range (read-only):	0 - 0xFFFF
Number of bytes returned:	2

Note: Firmware versions contain four significant digits - "A.B.C.D". If B=2, the module is programmed for operation in Australia only.

WA (Active Warning Numbers) Command

<Diagnostics> The WA command reports the warning numbers of all active warnings – one warning number per line. No further information is shown and warning counts are not reset.

AT Command:	ATWA
Parameter Range:	Returns string - one warning number per line.

Sample Output (indicates warnings 1 and 3 are currently active):
 1
 3
 OK

WN (Warning Data) Command

<Diagnostics> WN command is used to report the following data for all active and sticky warnings:

- Warning number & description
- Number of occurrences since the last WN or WS command
- Whether the warning is currently active

Warnings, which are not currently active and have not been active since the last issuance of the WN or WS commands, are not displayed. The WN command also resets all non-zero warning counts; except for warnings that are presently active, which are set to 1.

Sample output: Warning 4: Over-temperature
5 occurrences; presently inactive.

AT Command: ATWN

Parameter Range: returns string

Warning #	Description
1	Under-voltage. This is caused if the supply voltage falls below the minimum threshold for the lowest power level (2.8 V). If/when the voltage rises above the threshold, the warning is deactivated. The module will not transmit below this voltage threshold.
2	Over-voltage. This is caused if the supply voltage exceeds 5.75 V. Transmission is not allowed while this warning is active.
3	Under-temperature. This is caused if the temperature sensed by the module is less than -40 C. The module does not artificially limit operation while this warning is active, but module functionality is not guaranteed.
4	Over-temperature. This is caused if the temperature sensed by the module is greater than 105 C. The module does not allow transmission nor reception while this warning is active. The warning is deactivated when the temperature falls to 100 C.
5	Power reduced. This is caused if the transmit power has to be reduced from the level programmed by PL Command due to insufficient supply voltage. The 1 W power level requires 4.75 V or higher; 500 mW requires 3.0 V or higher; 100 mW, 10 mW and 1 mW require 2.8 V or higher.
6	Default calibration data in flash. This is caused if the module-specific power calibration data is either not present or is invalid, or if none of the parameters have been modified from their default values. Power levels may be incorrect.
7	Default configuration parameters in flash. This is caused if user-modifiable parameters (i.e. those stored by a 'WR' command) in flash are all the compiled-in default values. This is caused if the user configuration is found to be not present or invalid at power-up and there is no custom configuration, or if no user-modifiable parameters have been modified from the compiled-in defaults. Modification of one or more parameters without the subsequent WR to commit the changes to flash will not deactivate this warning, since it reflects the status of the parameters in flash. Note that this warning does not reflect usage of the custom configuration defaults, only usage of the compiled-in defaults.
8	Default factory configuration parameters in flash. This is caused if the factory parameters in flash are all the default values. This is caused if the factory configuration is found to be not present or invalid at power-up, or if no factory parameters have been modified.

WR (Write) Command

AT Command: ATWR

<(Special)> The WR

Binary Command: 0x08

command is used to write

configurable parameters to non-volatile memory (Values remain in the module's memory until overwritten by another use of WR Command).

If changes are made without writing them to non-volatile memory, the module will revert back to previously saved parameters the next time the module is powered-on.

If the non-volatile user configuration is not correct, WR will re-attempt (up to 3x). If all three attempts fail, the command will return an ERROR alert.

WS (Sticky Warning Numbers) Command

AT Command: ATWS

<Diagnostics> The WS

Parameter Range (read-only): 1 - 8

command reports warning

Number of bytes returned: 1

numbers of all warnings active

since the last use of the WS or WN command (including any warnings which are currently active). This command also resets all non-zero warning counts, except for warnings that are presently active, which are set to 1.

API Operation

By default, ZP9D-115RM-LR Radio Modem acts as a serial line replacement (Transparent Operation) - all UART data received through the DI pin is queued up for RF transmission. When the module receives an RF packet, the data is sent out the DO pin with no additional information.

Inherent to Transparent Operation are the following behaviors:

- If module parameter registers are to be set or queried, a special operation is required for transitioning the module into Command Mode [refer to p17].
- In point-to-multipoint systems, the application must send extra information so that the receiving module(s) can distinguish between data coming from different remotes.

As an alternative to the default Transparent Operation, API (Application Programming Interface) Operations are available. API operation requires that communication with the module be done through a structured interface (data is communicated in frames in a defined order). The API specifies how commands, command responses and module status messages are sent and received from the module using a UART Data Frame.

API Frame Specifications

Two API modes are supported and both can be enabled using the AP (API Enable) command. Use the following AP parameter values to configure the module to operate in a particular mode:

- AP = 0 (default): Transparent Operation (UART Serial line replacement)
API modes are disabled.
- AP = 1: API Operation
- AP = 2: API Operation (with escaped characters)

Any data received prior to the start delimiter is silently discarded. If the frame is not received correctly or if the checksum fails, the data is silently discarded.

API Operation (AP parameter = 1)

When this API mode is enabled (AP = 1), the UART data frame structure is defined as follows:

UART Data Frame Structure:



MSB = Most Significant Byte, LSB = Least Significant Byte

API Operation - with Escape Characters (AP parameter = 2)

When this API mode is enabled (AP = 2), the UART data frame structure is defined as follows:

UART Data Frame Structure with escape control characters:

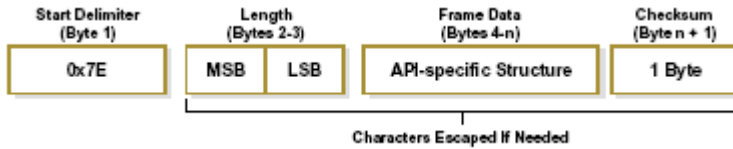

MSB = Most Significant Byte, LSB = Least Significant Byte

Escape characters. When sending or receiving a UART data frame, specific data values must be escaped (flagged) so they do not interfere with the UART or UART data frame operation. To escape an interfering data byte, insert 0x7D and follow it with the byte to be escaped XOR'd with 0x20.

Data bytes that need to be escaped:

- 0x7E – Frame Delimiter
- 0x7D – Escape
- 0x11 – XON
- 0x13 – XOFF

Example - Raw UART Data Frame (before escaping interfering bytes):

0x7E 0x00 0x02 0x23 0x11 0xCB

0x11 needs to be escaped which results in the following frame:

0x7E 0x00 0x02 0x23 0x7D 0x31 0xCB

Note: In the above example, the length of the raw data (excluding the checksum) is 0x0002 and the checksum of the non-escaped data (excluding frame delimiter and length) is calculated as:

$$0xFF - (0x23 + 0x11) = (0xFF - 0x34) = 0xCB.$$

Checksum

To test data integrity, a checksum is calculated and verified on non-escaped data.

To calculate: Not including frame delimiters and length, add all bytes keeping only the lowest 8 bits of the result and subtract from 0xFF.

To verify: Add all bytes (include checksum, but not the delimiter and length). If the checksum is correct, the sum will equal 0xFF.

API Types

Frame data of the UART data frame forms an API-specific structure as follows:

UART Data Frame & API specific Structure:

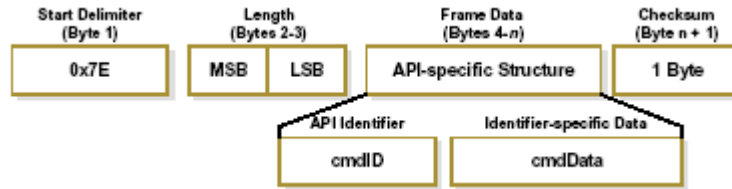

The cmdID frame (API-identifier) indicates which API messages will be contained in the cmdData frame (Identifier-specific data). Refer to the sections that follow for more information regarding the supported API types. Note that multi-byte values are sent big endian.

RF Module Status

API Identifier: 0x8A

RF module status messages are sent from the module in response to specific conditions.

RF Module Status Frames

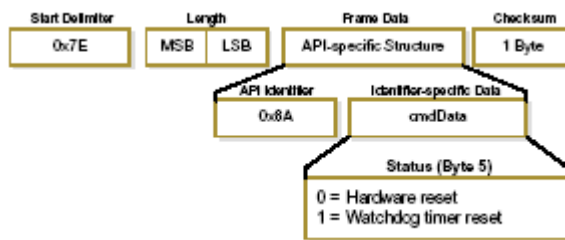

TX (Transmit) Request: 16-bit address

API Identifier Value: 0x01

A TX Request message will cause the module to send RF Data as an RF Packet.

TX Packet (16 bit address) Frames

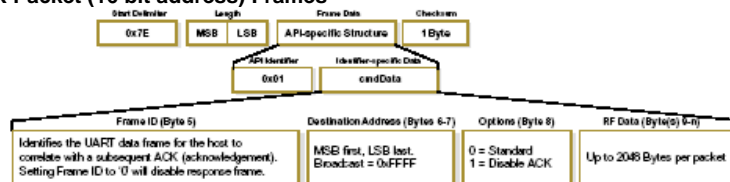

Example: TX Packet API Frames



* Length (Byte) = API Identifier + Frame ID + Option + RF Data
 ** "R" value was arbitrarily selected

TX (Transmit) Status

API Identifier Value: 0x89

When a TX Request is completed, the module sends a TX Status message. This message will indicate if the packet was transmitted successfully or if there was a failure.

TX Status Frames

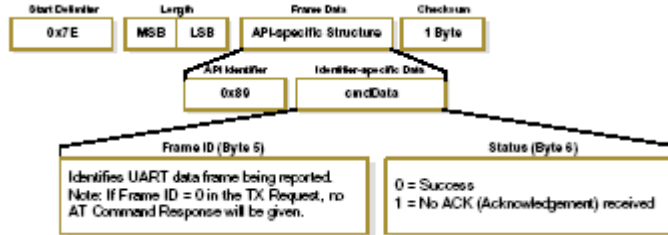

NOTE: "STATUS = 1" occurs when all retries are expired and no ACK is received.
 "STATUS = 3" occurs when a packet is purged due to a 'Polled Remote' not receiving a poll.

RX (Receive) Packet: 16-bit address

API Identifier Value: 0x81

When the module receives an RF packet, it is sent out the UART using this message type.

RX Packet (16 bit address) Frames

